

Ambient Noise in the Sea off Thule, North Greenland

Ødegaard & Danneskiold-Samsøe K/S

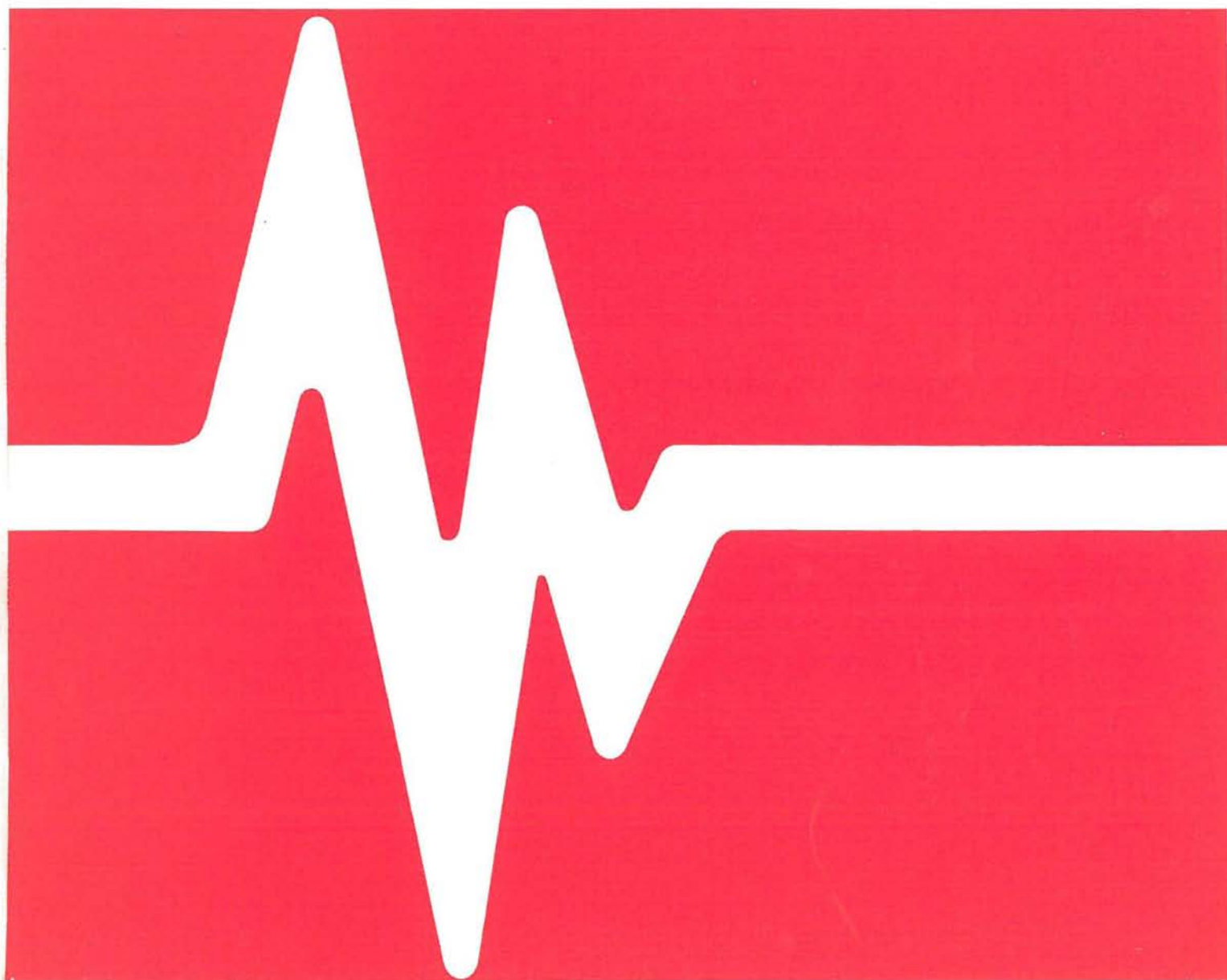

Ødegaard & Danneskiold-Samsøe K/S

Rådgivende ingeniører - Støj og vibrationer
Consulting Engineers - Noise and Vibration

Kroghsgade 1
DK-2100 Copenhagen Ø
Denmark
Telefon: 01-26 6011
Telex: 19710 oedan dk



Report 83.88

AMBIENT NOISE IN THE SEA
OFF THULE, NORTH GREENLAND

Greenland Fisheries Investigations
Tagensvej 135, 1.
2200 København N
Denmark

November 1983

Prepared by

Lars Thiele



FOREWORD

This investigation has been carried out as part of the assessment of the impact on the environment caused by the "Arctic Pilot Project". This project involves shipping of liquefied natural gas in ice-breaking carriers through Lancaster Sound, Baffin Bay and Davis Strait.

The ambient noise measurements, the signal analysis, and the reporting have been performed by Ødegaard & Danneskiold-Samsøe.

The laboratory analysis and reporting has been financed by a grant from The Greenland Fisheries Investigations.

Special thanks is expressed to the many Greenlanders in Moriussaq and Qaanaaq, who helped during the measurements. Without their help this investigation would not have been possible. Special thanks is also expressed to Mrs. Inger Plum, who kindly assisted during the field measurements in Greenland.



CONTENTS

SUMMARY..... 4

1. INTRODUCTION..... 5

2. AMBIENT NOISE IN ARCTIC WATERS..... 6

3. GEOGRAPHICAL LOCATIONS AND MEASURING CONDITIONS... 8

4. AMBIENT NOISE MEASUREMENTS..... 13

 4.1 Method..... 13

 4.2 Instrumentation..... 14

 4.3 Signal analysis..... 15

5. RESULTS..... 16

6. COMMENTS..... 18

7. CONCLUSION..... 20

APPENDIX

A. Results and data from each recording..... A1



SUMMARY

This report describes the results of ambient underwater noise measurements carried out in the summer of 1983 in the sea off Thule, North Greenland. The measurements were undertaken to evaluate the possible impact of increased ship traffic on the natural ambient underwater noise in these areas. The investigation is especially related to the "Arctic Pilot Project", which includes plans to apply ice-breaking LNG-tankers for shipping natural gas through Baffin Bay and Davis Strait.

The measurements were carried out from a small boat at different locations off the coast in the Thule area. The ambient noise level was measured at two different depths at each measuring position.

The tape recordings were later analysed in the laboratory. The results are presented as statistical distributions of the underwater noise level as a function of frequency.

The results of the measurements and the analysis show that the underwater noise consists partly of a steady broadband noise and partly of loud pulses.

The results from the two hydrophone depths indicate that the noise level tends to be higher at the greater depth. This tendency however is not consistent as nearby noise sources close to the surface will produce the opposite effect.

At the frequency range below 250 Hz, the average noise level is found to be lower than previously measured in the summer at Baffin Bay, as published by Leggat and Merklinger, Ref. /1/. At higher frequencies, the results agree reasonably well with the results published in Ref. /1/.

At lower frequencies, the results agree with the results from similar measurements performed from the ice cover during winter off Kap York. At the higher frequency range, the measured levels are higher than previously measured during winter off Kap York.



1. INTRODUCTION

One of the main problems in the exploitation of energy resources in the Canadian Arctic is the transportation of oil or gas to the markets in the south. One project, the "Arctic Pilot Project", involves transportation of liquefied natural gas (LNG) in large ice-breaking tankers. The tankers' route is planned to be from Melville Island through Lancaster Sound, Baffin Bay and Davis Strait to a harbour in the South of Canada or in Europe, see Figure 1.

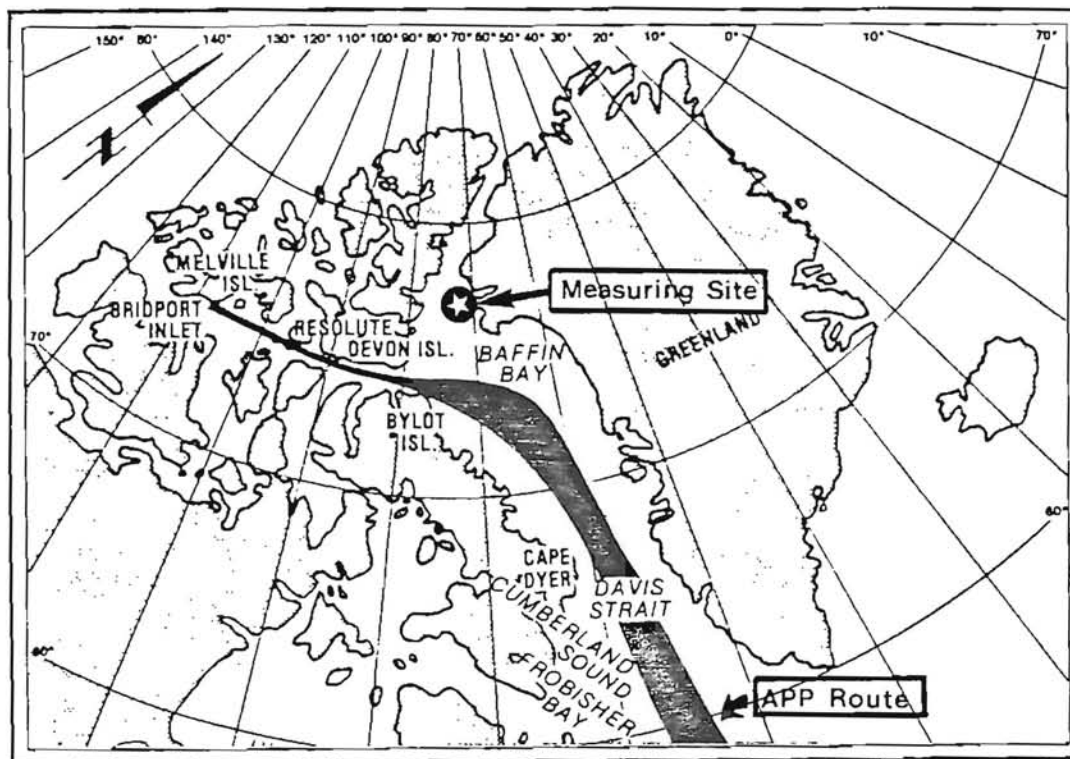

Figure 1.
Planned route of the LNG-carriers and the measuring site for the ambient noise measurements.

Concern has been raised that the underwater noise from the propellers of the LNG-carriers will influence the acoustic environment in the sea, on which especially the marine mammals are dependent. Traffic in these areas has until now only been performed by few and small ships and only during the ice-free summer period.



In order to evaluate the impact of the propeller noise on the ambient underwater noise, it is necessary to know the source level of underwater noise from the propellers of the LNG-carriers, the sound transmission properties of the waters through which they pass, and the ambient noise level along the route.

Some investigations have been performed to evaluate these parameters. Predictions of the source level of the radiated propeller noise from the LNG-carriers have been dealt with in e.g. Ref. /1/, /2/, /3/ and /4/. Other investigations deal with the transmission loss and the ambient noise in the arctic waters e.g. /1/, /5/, /6/ and /7/.

This report describes the results of ambient noise measurements carried out in the summer period in the waters off the Thule area in North Greenland, see Figure 1. The measurements were performed at five different locations, in order to obtain ambient noise data at positions with varying water depths, ice conditions, weather conditions, etc. The ambient noise was recorded simultaneously from hydrophones at depths of 5 metres and 50 metres.

As the measurements were carried out in the course of a few days, this report does not pretend to give a complete description of the ambient noise in the area. In order to make a complete description, measurements have to be performed at many different positions and at various weather and ice conditions. Nevertheless, the results presented give a reasonable indication of the ambient underwater noise levels close to the planned LNG-carrier route under typical summer conditions.

2. AMBIENT NOISE IN ARCTIC WATERS

The ambient underwater noise level in arctic regions, even in the summer period, is strongly affected by the presence of ice in the sea. The noise generated by the ice is caused by the following processes:



- Cracking induced by thermal stress
- Interaction of the ice caused by wind, currents or waves
- Icebergs capsizing or breaking
- Release of entrapped air in melting ice
- Ice interacting with the sea-bed or the shore

The thermal stress is due to changes in the air temperature and the correlation with the ambient noise level is observed in many investigations, for example by Milne and Ganton, Ref. /7/.

There will always be movements of the ice because of tidal currents and wind forces. In areas with a dense ice cover, this will cause the ice floes to rub against one another and thereby generate noise. In the summer this can be seen at the boundary between an ice-covered area and open water where the noise generation is often high, due to the movements of the ice caused by waves and the open structure of the ice along the edge. The high underwater noise levels at the ice edge were recorded in the investigation carried out by Diachok and Winokur, Ref. /8/. Measured noise levels near the ice edge were about 10 dB higher than under the fast ice cover or in the open water.

Owing to melting or to thermal stresses the icebergs often break apart or lose balance and capsize. This will generate very high underwater noise levels, which propagate over great distances because of the low sound transmission loss in arctic waters. High sound pressure levels at low frequencies were measured close to a small iceberg capsizing as described by Leggat in Ref. /1/.

In melting ice a steady release of entrapped air bubbles will cause underwater noise. This phenomenon has been described by divers, who say that close to an iceberg the visibility is very poor and that it is like diving in "soda water".

Icebergs sometimes interact with the sea-bed, even in areas with relatively deep water. This interaction between the icebergs and the sea-bed will inevitably result in a considerable amount of noise when current and wind move the icebergs.



Apart from the ice, other sources also influence the ambient noise level, such as waves and rain. Furthermore, sounds generated by marine mammals, fish, and invertebrates contribute to the ambient noise level.

3. GEOGRAPHICAL LOCATIONS AND MEASURING CONDITIONS

The recording of the ambient underwater noise was carried out from a small dinghy with an outboard motor. The motor was stopped during all measurements.

In order to obtain measurements under different conditions, the recordings were made at five different locations. A chart from the area with the measuring positions is shown in Figure 2. The longitude and latitude of each position are given in Table 1.

Each position is described in the following, and photos from the measuring sites are shown in Figures 3, 4 and 5.

Position	Latitude	Longitude	Water Depth
A	76° 38' N	70° 40' W	150 m
B	76° 45' N	70° 10' W	100 m
C	77° 17' N	70° 40' W	900 m
D	77° 27' N	67° 50' W	750 m
E	77° 29' N	67° 00' W	Unknown

Table 1.
Measuring positions.

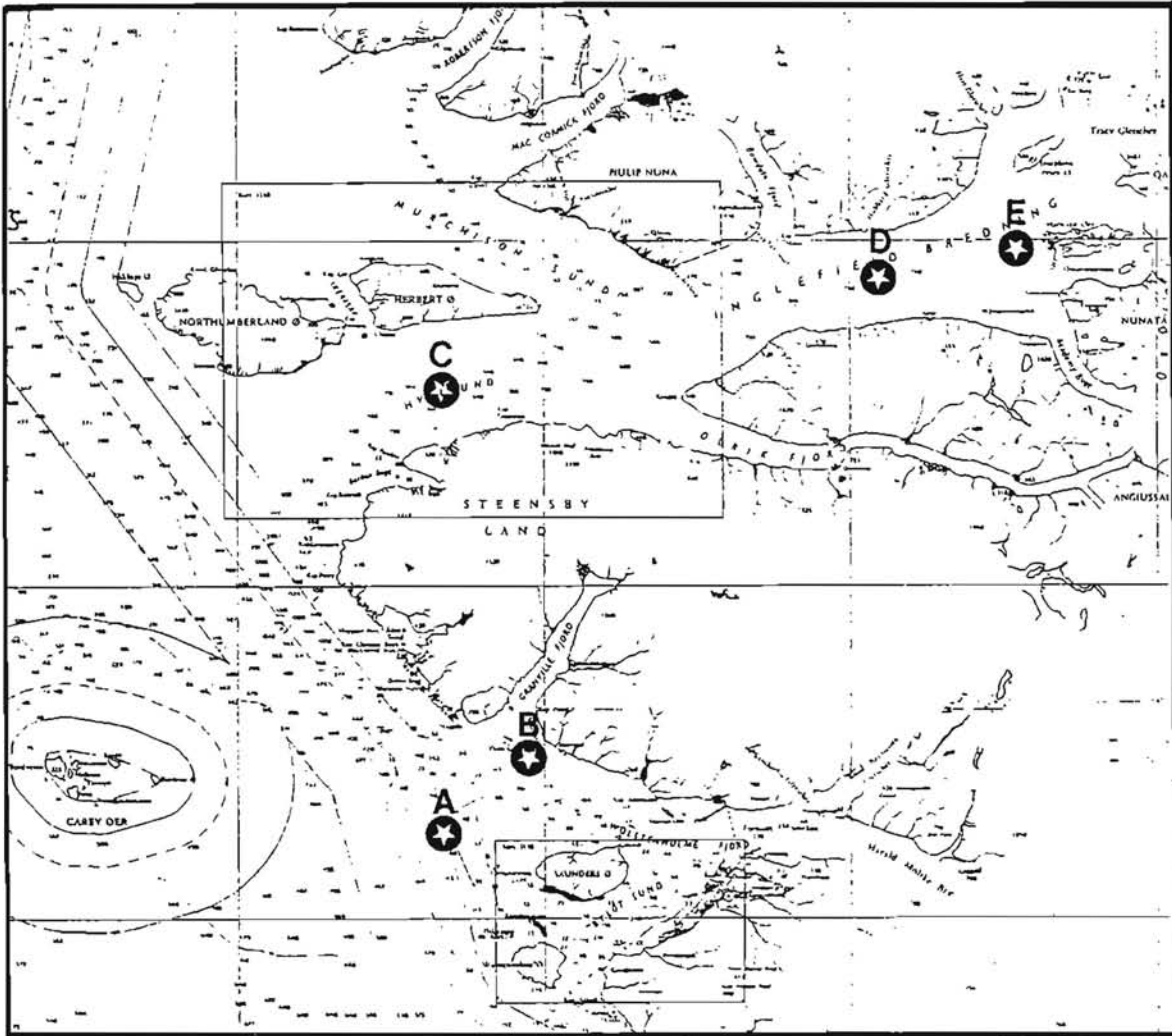

Figure 2.
Chart of the area with indication of the measuring positions.

Position A

Position A was situated in an open water area with few drifting icebergs and some bergy bits and growlers. The weather was calm with a 2-4 m/s westerly wind and some small waves. The air temperature was approximately 5° Celcius.

The water depth in the area was approximately 150 metres and the distance to the nearest coast, Saunders Island, was 18 km. Distance to the nearest ice (a bergy bit) was approximately 1 km. A photograph taken from the measuring site is shown in Figure 3.



Figure 3.
Photograph from measuring position A.

Recordings with hydrophones at depths of 5 metres and 50 metres were performed on the 83.07.25 at 14.00 and at 14.45. The duration of each recording was 25 minutes.

Furthermore, a recording was carried out from the nearest bergy bit with the hydrophone placed at a depth of 50 metres below it.

Position B

The measurements at this position were performed on the way home to Moriussaq, in order to gather some data from a location closer to the coast. The ice- and weather conditions were as for position A. The water depth was 100 metres and the distance to the coast was 5.5 km. An outboard motor could be heard periodically on the signals from the hydrophones but no boat was visible. One recording (25 minutes) was performed on 83.07.25 at 17.30 with the hydrophones at depths of 5 metres and 50 metres.



Position C

The intention with this position was to obtain a measurement in deep waters, well clear of the coast. Unfortunately, it was impossible to do the measurements far from the coast due to hard winds and too high waves. Instead the measurement was carried out from a position in the inlet of Inglefield Bay where the weather was much calmer. The water depth was approximately 900 metres and the distance to the nearest coast was 9 km.

The weather conditions at the measuring site were calm with 4 m/s westerly winds and some small waves. The air temperature was approximately 5° Celcius. A few icebergs were drifting at a distance of approximately 5 km. Some bergy bits and growlers were closer. In order to prevent the dinghy from drifting too fast, it was tied to a small chunk of ice (approximately 1 m³). A photograph from the area is shown in Figure 4.

One recording (25 minutes) with the hydrophones at depths of 5 metres and 50 metres was performed on the 83.07.27 at 21.20.

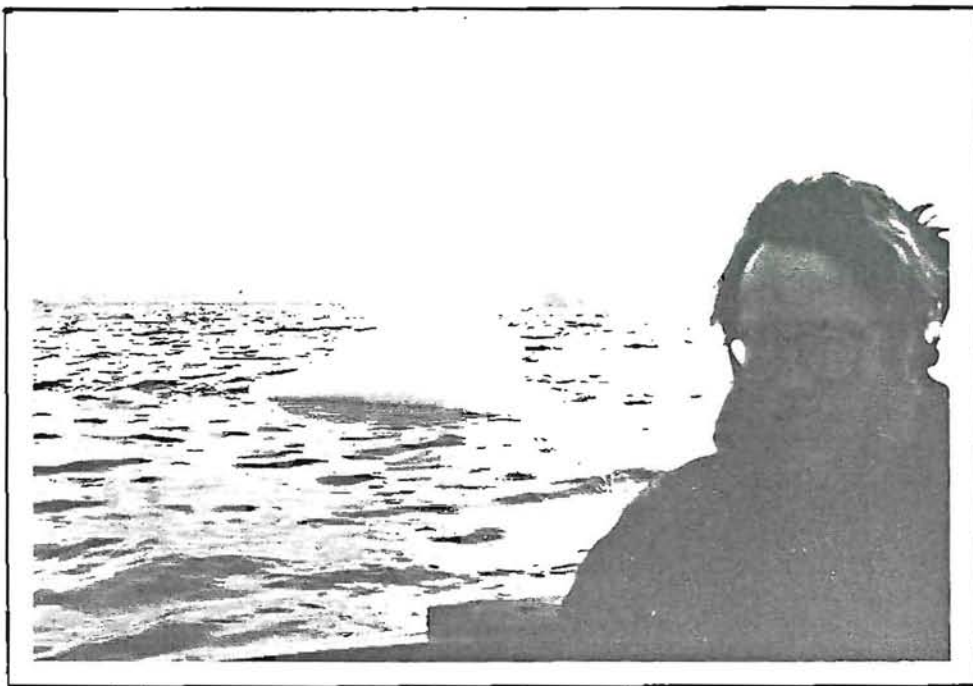

Figure 4.
Photograph from measuring position C.



Position D

This position was located in the middle of the Inglefield Bay at the edge of a large ice covered area. A few icebergs, bergy bits and growlers were drifting in the area. The water depth was approximately 700 metres and the distance to land was 7 km. A photograph taken from the area is shown in Figure 5.

The weather was calm with no wind or waves. The recordings were performed from the ice with the dinghy pulled up on the ice. One recording (25 minutes) with the hydrophones at depths of 5 metres and 50 metres was performed on the 83.07.28 at 20.00.

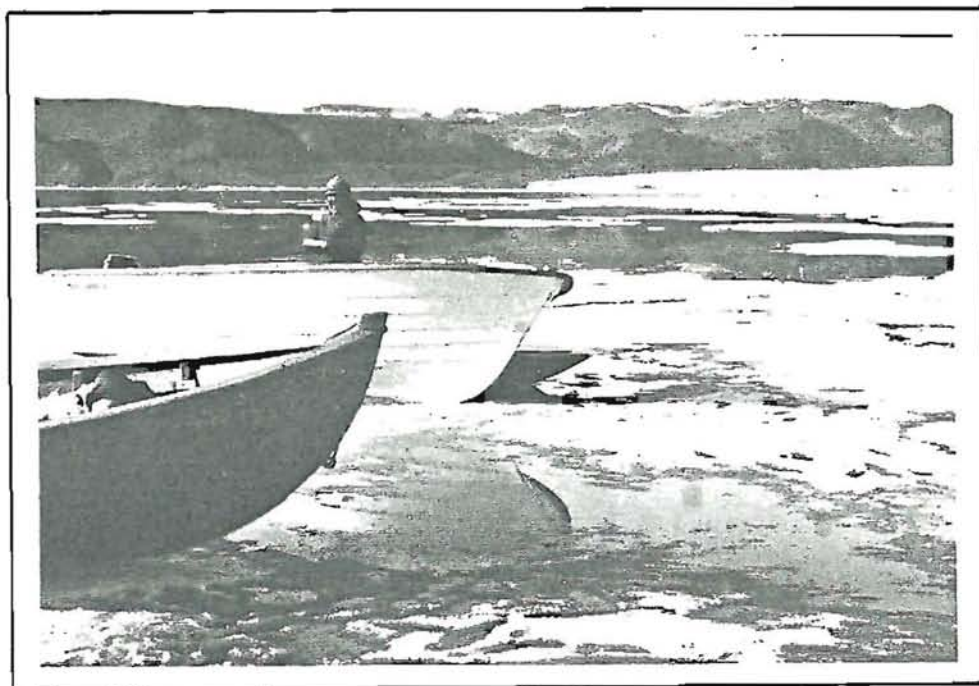

Figure 5.
Photograph from measuring position D.

Position E

This last position was at the end of the Inglefield Bay in an area with open pack ice, the ice concentration being approximately 4/10. The water depth is unknown and the distance to land



(Harward Islands) was approximately 6.5 km. A photograph from the area is shown in Figure 6. The weather was calm with no wind or waves. Due to a strong current in the water a couple of metres below the surface, it was not possible to make any recording with the hydrophone at a depth of 50 metres. One recording with the hydrophone at a depth of 5 metres was carried out on the 83.07.29 at 12.00.

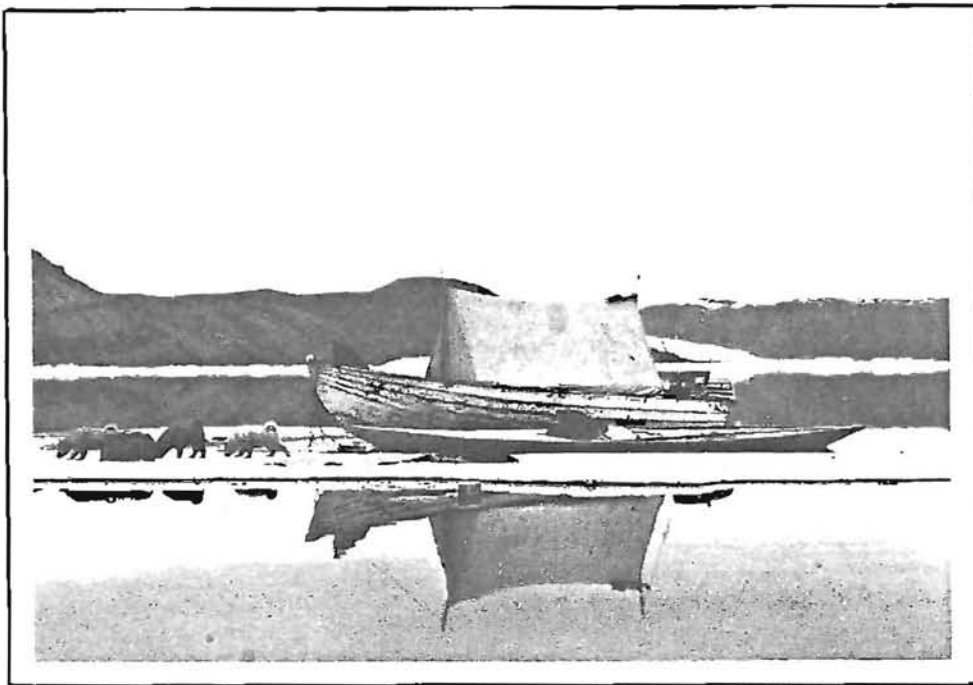

Figure 6.
Photograph from measuring position E.

4. AMBIENT NOISE MEASUREMENTS

4.1 Method

The ambient noise recordings were made with two precision hydrophones immersed into the water from a small dinghy.

The hydrophones and their extension cables were balanced in the water by means of a small submerged buoy, in order to prevent motion of the hydrophones due to the movements of the boat on the surface. The arrangement is shown in Figure 7. The signals from the hydrophones were recorded on a tape-recorder placed in the



dinghy. During the measurements the people onboard did not move or speak. The measuring positions were determined by taking bearings to known points on land. The water depth was found from the chart of the area.

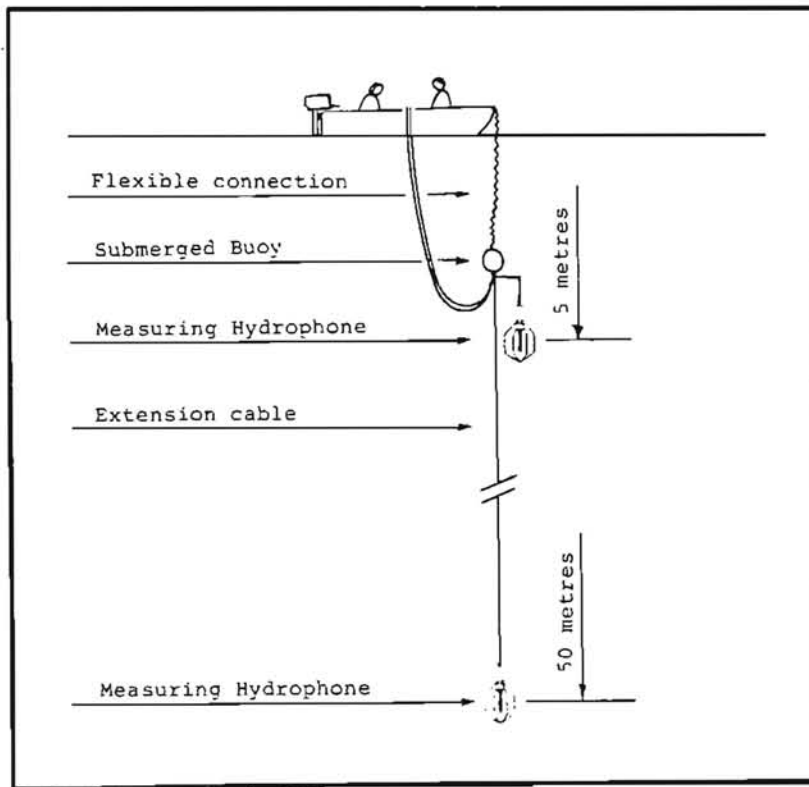

Figure 7.
Arrangement of the hydrophones.

4.2 Instrumentation

The measurements of the underwater noise were carried out with two high sensitivity piezoelectric hydrophones with built-in preamplifiers connected to a power supply and measuring amplifiers through special watertight extension cables. The signals from the amplifiers were recorded on two precision measuring tape recorders. The arrangement of the instruments is illustrated in Figure 8. The instruments employed are listed in Table 2.

2 x Hydrophone	Brüel & Kjær, Type 8101
Hydrophone Calibrator	Brüel & Kjær, Type 4223
Extension Cables	Brüel & Kjær, Type A00113
Power Supply	Brüel & Kjær, Type 2804
2 x Charge Amplifiers	Brüel & Kjær, Type 2635
Tape Recorder	Nagra Kudelski, Type IS-D
Tape Recorder	Nagra Kudelski, Type III

Table 2.
Instruments used for the measurements.

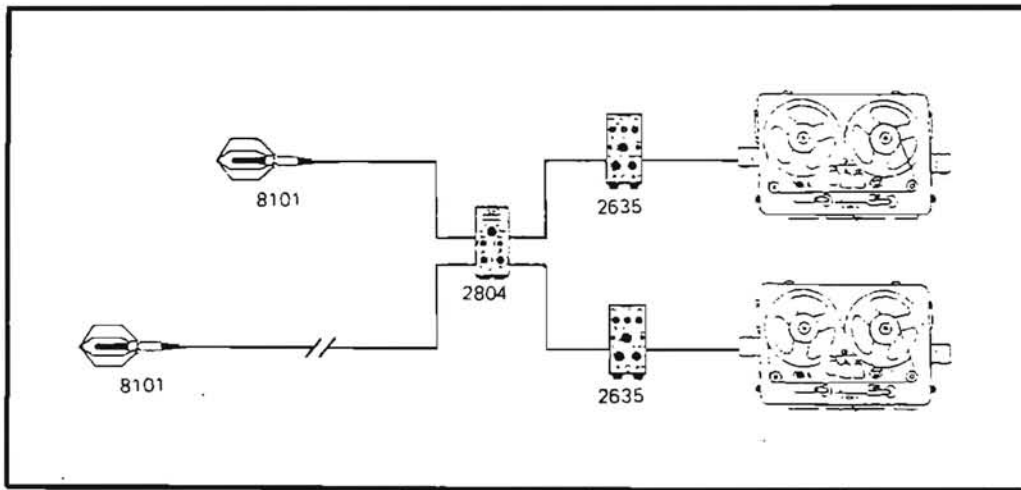

Figure 8.
Arrangement of the instruments.

4.3 Signal analysis

The ambient noise signals are non-stationary in character. It was thus necessary to perform a statistical analysis of the tape-recorded noise signals. This was undertaken in the laboratory after the return from Greenland. During the statistical analysis, the levels exceeded for 1, 50 and 90 per cent of the time, were found for the one octave frequency bands with centre frequencies from 31.5 Hz to 4000 Hz. Duration of the analysis was approximately 22 minutes from each of the recordings and the integration time used was 250 ms. The instruments used for the analysis are listed in Table 3.

Tape Recorders	Nagra Kudelski , Type IS-D and III
Digital Frequency Analyser	Brüel & Kjær , Type 2131
Level Recorder	Brüel & Kjær , Type 2307
Computer	Hewlett Packard, Type 1000 F

Table 3.
Instruments used for analysis.



5. RESULTS

The results of the statistical analysis for each of the recordings are given in Appendix A where the spectrum levels L_1 , L_{50} and L_{99} are shown (levels exceeded for 1, 50 and 99 per cent of the time). Furthermore, a recording of the overall level are shown together with meteorological data and comments. All the results are presented as spectrum levels expressed in dB re $1 \mu\text{Pa}/\sqrt{\text{Hz}}$. The overall levels are recorded in the frequency interval 0-8000 Hz with an integration time of 250 ms.

An example of the statistical analysis is given in Figure 9 where the L_1 , L_{50} , and L_{99} levels measured at location A at a depth of 50 metres (recording no. 2A) are shown.

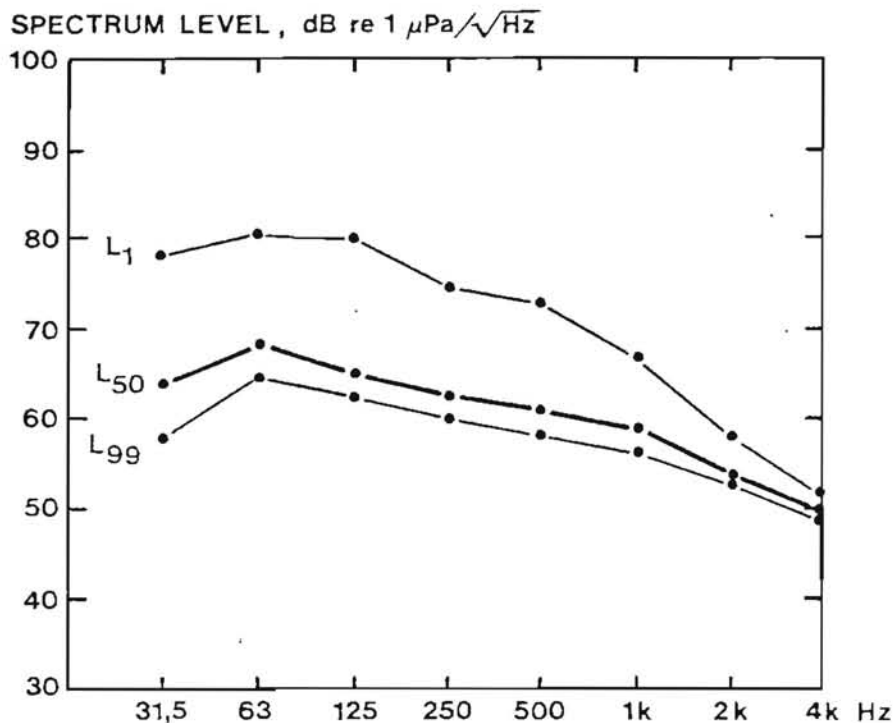

Figure 9.
Example of ambient noise measured at
position A. Hydrophone depth 50 metres.

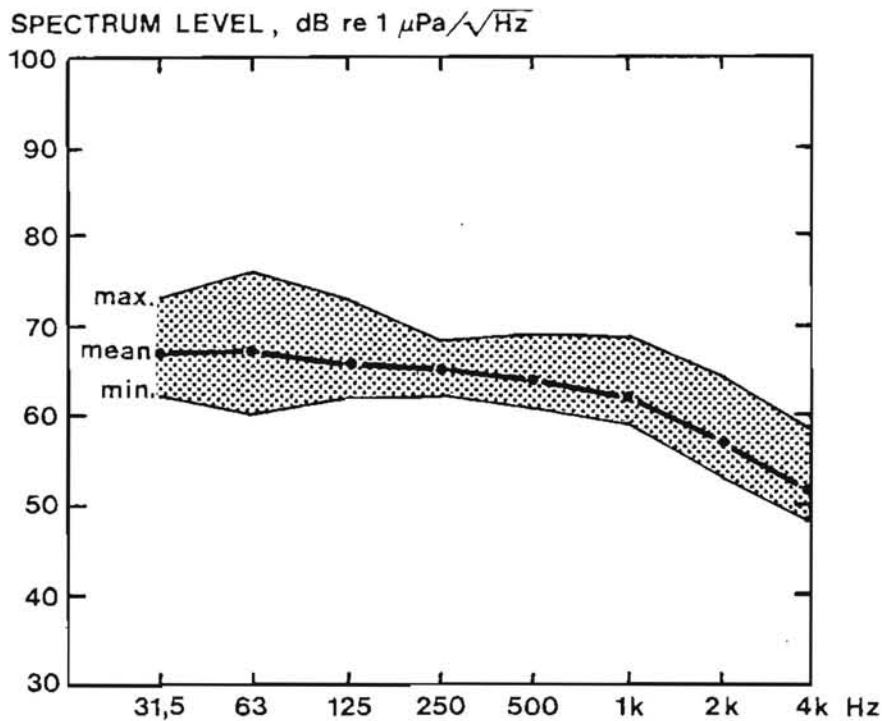

Figure 10.

Range of all the L_{50} spectrum levels measured at the five positions from both 5 metres and 50 metres depth.

The range of the measured underwater noise levels is illustrated in Figure 10, where the maximum, average and minimum L_{50} levels of the recordings are shown. The average L_{50} levels are found as the arithmetic average of the 12 recordings.

It appears from Figure 10 that the variations in the noise levels are about 15 dB in the low frequency range and approximately 10 dB at the higher frequencies. The highest spectrum levels occur in the low frequency range whereas the spectrum levels are lower at higher frequencies.

The measured ambient noise levels are dependent of the measuring position and hydrophone depth and this is illustrated in Figure 11. This figure shows the levels measured at position A and D for hydrophone depths of 5 metres and 50 metres. Position A is located in relatively open water, clear of the coast while position D is located close to an ice covered area inside the Inglefield Bay.

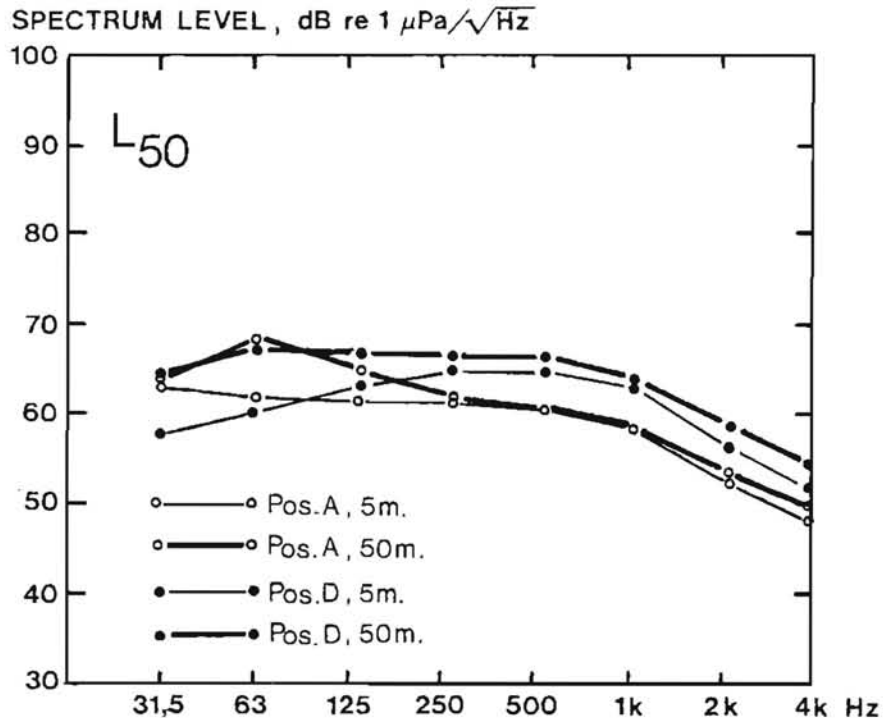

Figure 11.
Measured ambient noise levels at position A
and D at depths of 5 metres and 50 metres.

It can be seen from Figure 11 that the results from these two positions do not differ much at low frequencies, while at high frequencies there is a tendency for higher levels to occur in the ice-covered area rather than in the open water.

The effect of the hydrophone depth can also be seen in Figure 11. The levels measured with the shallow (5 metres) hydrophone is generally lower than that measured with the deep (50 metres) hydrophone.

6. COMMENTS

The noise can be characterized as a constant broadband noise superposed by intermittent pulses of various strength. This is illustrated in the overall level recordings shown in Figure 12.

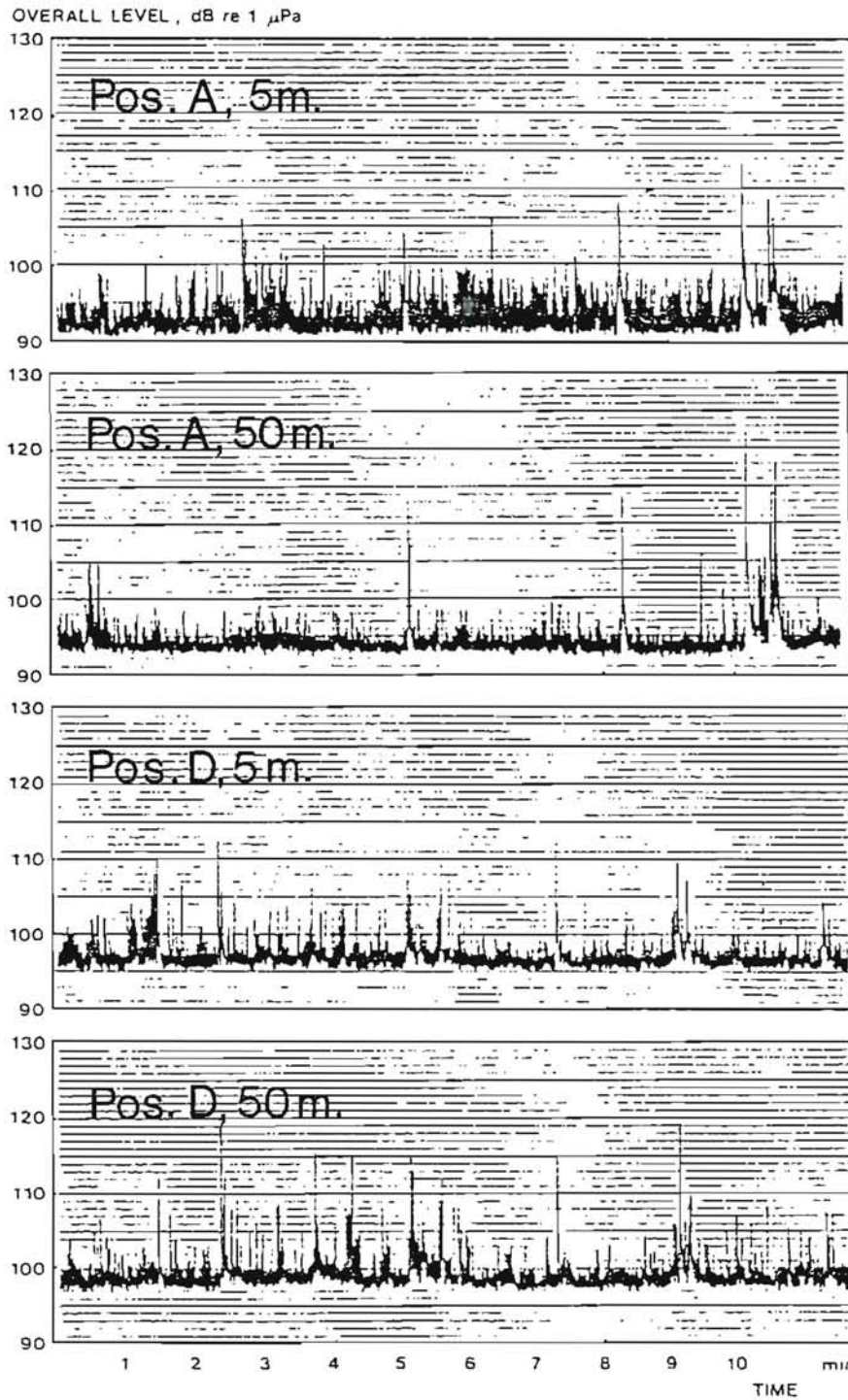

Figure 12.
Examples of overall noise level versus time.



Figure 12 also illustrates how the noise level varies with the depth of the measuring hydrophone. It can be seen that the overall level is higher at the deep hydrophone than at the shallow hydrophone.

This applies to the broadband noise and especially to the pulses. The reason for measuring higher levels at the deeper hydrophone is probably the pressure release effect occurring near the surface. On the recording at position A with a hydrophone depth of 5 metres, the signal is contaminated by noise from small waves splashing on the dinghy. This is seen as fluctuations in the base of the curve.

Other recordings with the shallow hydrophone are also contaminated by noise from nearby sources such as waves or melting ice. This is seen, for example, in the recording at position C (No. 5B) where noise from a small growler dominates. As the dinghy drifts away from the ice, the overall noise level decreases by 8 dB, as seen in Appendix A.10.

Only very few sounds from marine mammals could be recognized during the recordings. Not even the characteristic sounds from the bearded seal, which were observed close to all the measuring sites, were heard.

7. CONCLUSION

The range of the underwater ambient noise levels measured in this investigation are compared to the results of other investigations from arctic waters in Figures 14, 15 and 16. In Figure 14, the measured levels are compared with the results reported by Leggat and Merklinger, Ref. /1/ from a measurement in Baffin Bay during the summer. In Figure 15, the levels are compared with the results obtained in the summer at Scoresby Sound, East Greenland, Ref. /5/.

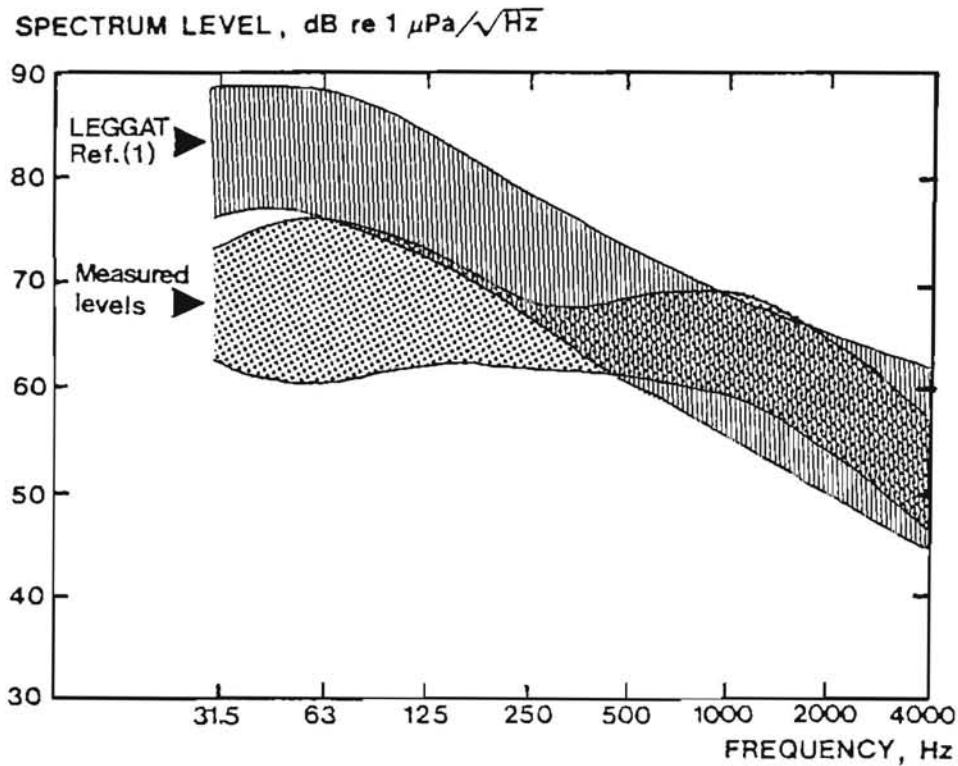

Figure 14.
Measured levels from this investigation compared with results reported by Leggat and Merklinger, Ref. /1/.

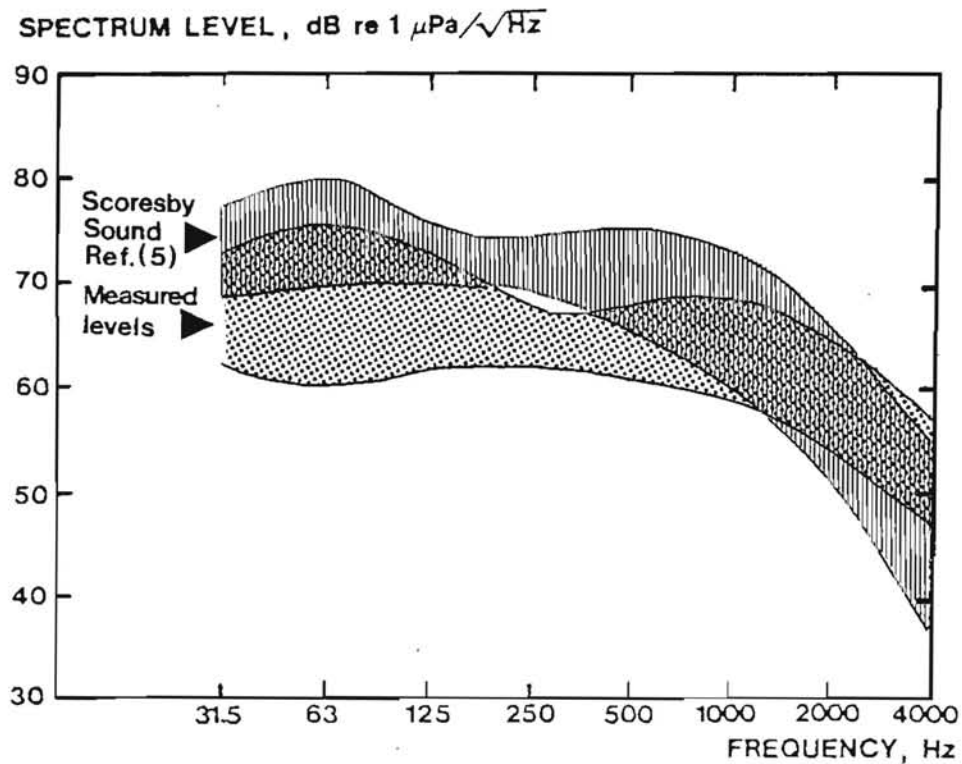

Figure 15.
Measured levels from this investigation compared with the results from Scoresby Sound, Ref. /5/.



From Figures 14 and 15 it can be seen that in the high frequency range the noise levels measured during this investigation are of the same magnitude as the other results. In the low frequency range, the results are approximately 8 dB lower than those measured at Scoresby Sound and approximately 15 dB lower than those measured by Leggat in Baffin Bay.

In Figure 16, the measured levels are compared with the results from the ambient noise measurement off Kap York. These measurements were also performed in the Thule area but during the winter, Ref. /6/.

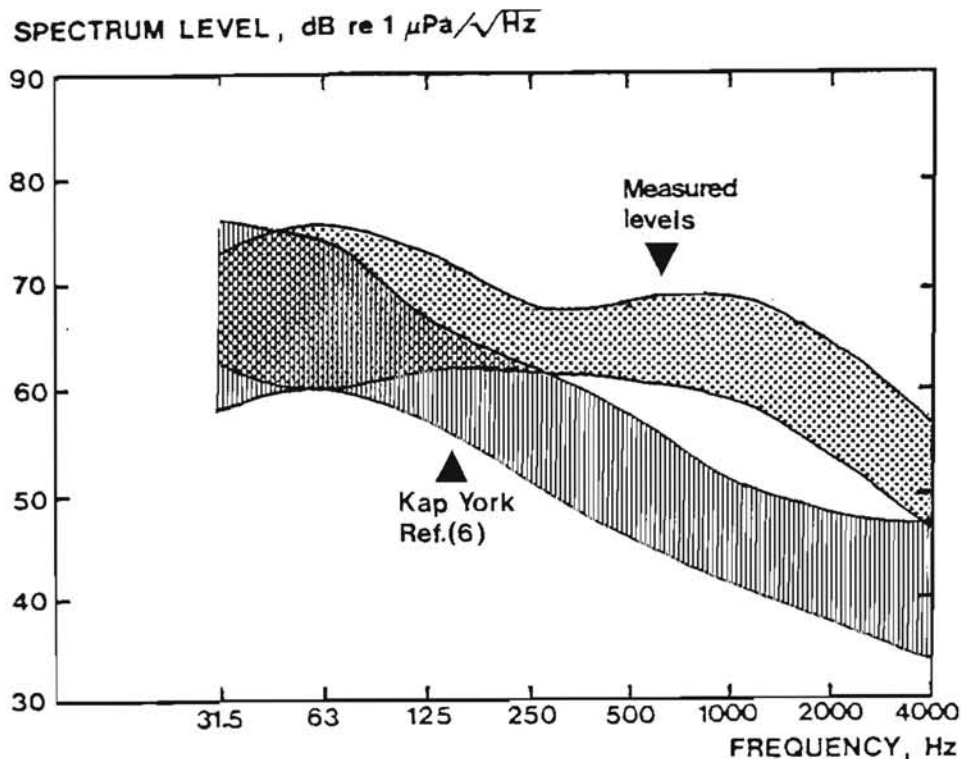

Figure 16.
Measured levels compared with the results from the measurement off Kap York performed during the winter.

From Figure 16 it can be seen that the range of the results from the two measurements do not differ much at frequencies below 125 Hz. At higher frequencies the measured levels are up to 20 dB higher than the levels recorded during the winter. This is probably due to the noise generated by the melting ice.



The ambient noise measurements in this investigation have been performed with hydrophones at two different depths. The noise levels measured at these two depths indicate that the level is generally higher at the deep hydrophone than at the shallow hydrophone. The difference is not very distinct, however, as local noise generated near the surface counteracts this effect. A more consistent tendency is seen with the noise signals received from sources far away from the measuring position. As an example can be mentioned the loud pulses from fracturing ice bergs, which is received with much higher levels at the deep hydrophone than at the shallow hydrophone.

REFERENCES

- /1/ Leggat, L., J. Merklinger, H.M & Kennedy, J.L.: LNG-carrier Underwater Noise Study for Baffin Bay. The Question of Sound from Icebreaker Operations. Proceedings of a Workshop. Toronto 1981. Petro Canada, Calgary, Alberta.
- /2/ Brown, N.: Revisions to the Integrated Route Analysis, Volume 2, Section 3.2.3.1 (Source Level Estimates). The Arctic Pilot Project, Calgary, April 1981.
- /3/ Thiele, L.: Underwater Noise from the Icebreaker M/S "VOIMA". Report 81.42, Ødegaard & Danneskiold-Samsøe, 1981.
- /4/ Thiele, L.: Underwater Noise from the Propellers of a Triple Screw Containership. Report 82.54, Ødegaard & Danneskiold-Samsøe, 1982.
- /5/ Thiele, L.: Noise in the Sea off Scoresbysund, East Greenland. Report 82.45, Ødegaard & Danneskiold-Samsøe, 1982.
- /6/ Thiele, L.: Ambient Noise in the Sea off Kap York, Melville Bay, North West Greenland. Report 82.53, Ødegaard & Danneskiold-Samsøe, 1982.
- /7/ Milne, A.R. and Ganton, J.H.: Ambient Noise under Arctic-Sea Ice. Journal of the Acoustical Society of America. Vol. 36, No. 5, 1964, pp 855-863.
- /8/ Diachock, O.I. and Winokur, R.s.: Spatial Variability of Underwater Ambient Noise at the Arctic Ice-water Boundary. Journal of the Acoustical Society of America. Vol. 55, No. 4, 1974, pp 750-753.

APPENDIX AResults and data from each recording

Recording No.	Position	Page
1 A	A	A 2
1 B	A	A 3
2 A	A	A 4
2 B	A	A 5
3 A	A	A 6
4 A	B	A 7
4 B	B	A 8
5 A	C	A 9
5 B	C	A 10
6 A	D	A 11
6 B	D	A 12
7 B	E	A 13

Recordings with a number followed by A were taken at a depth of 50 metres, while numbers followed by B were taken at a depth of 5 metres.



A2

Recording No.: 1 A
Date: 25th July 1983
Measuring position: A

Time: 14.00
Water depth: 150 m
Hydrophone depth: 50 m

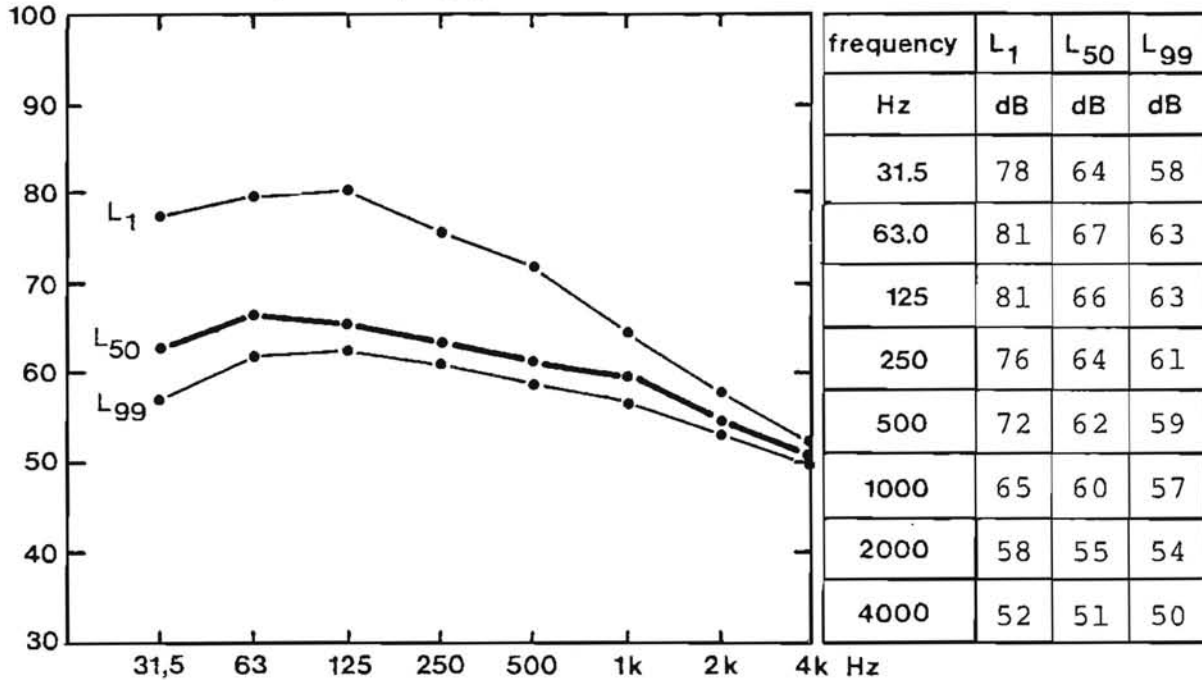
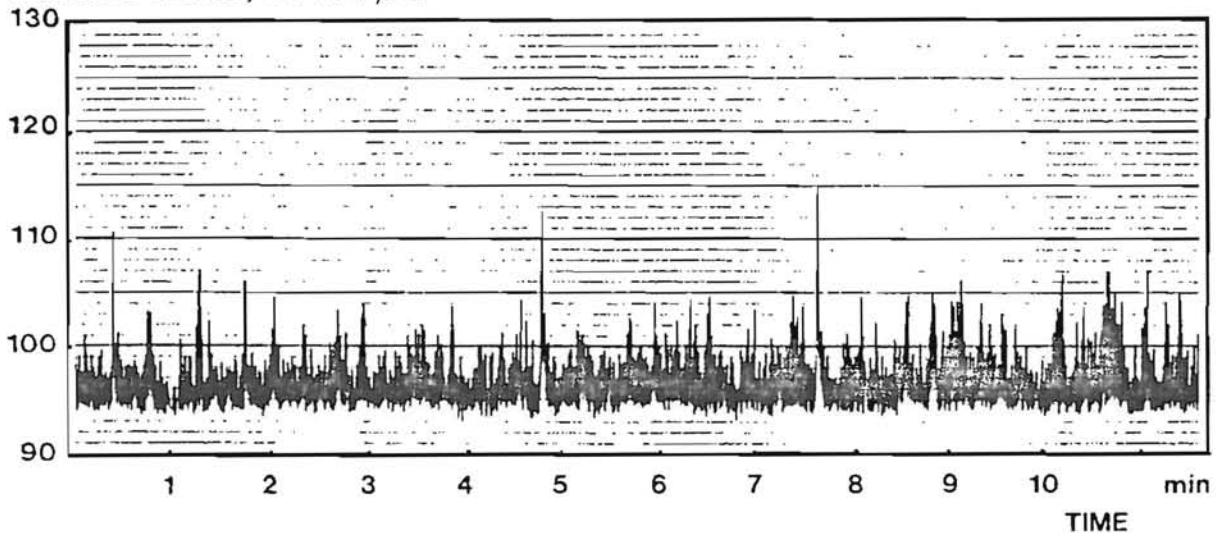
SPECTRUM LEVEL, dB re $1 \mu\text{Pa}/\sqrt{\text{Hz}}$ OVERALL LEVEL, dB re $1 \mu\text{Pa}$ 

Wind: 2-4 m/s

Wind direction: West

Temperature: 5° C

Weather conditions: Overcast

Remarks: Measured from the dinghy in open water with few drifting icebergs, bergy bits and growles. The dinghy was drifting for the wind.



Recording No.: 1 B
Date: 25th July 1983
Measuring position: A

Time: 14.00
Water depth: 150 m
Hydrophone depth 5 m

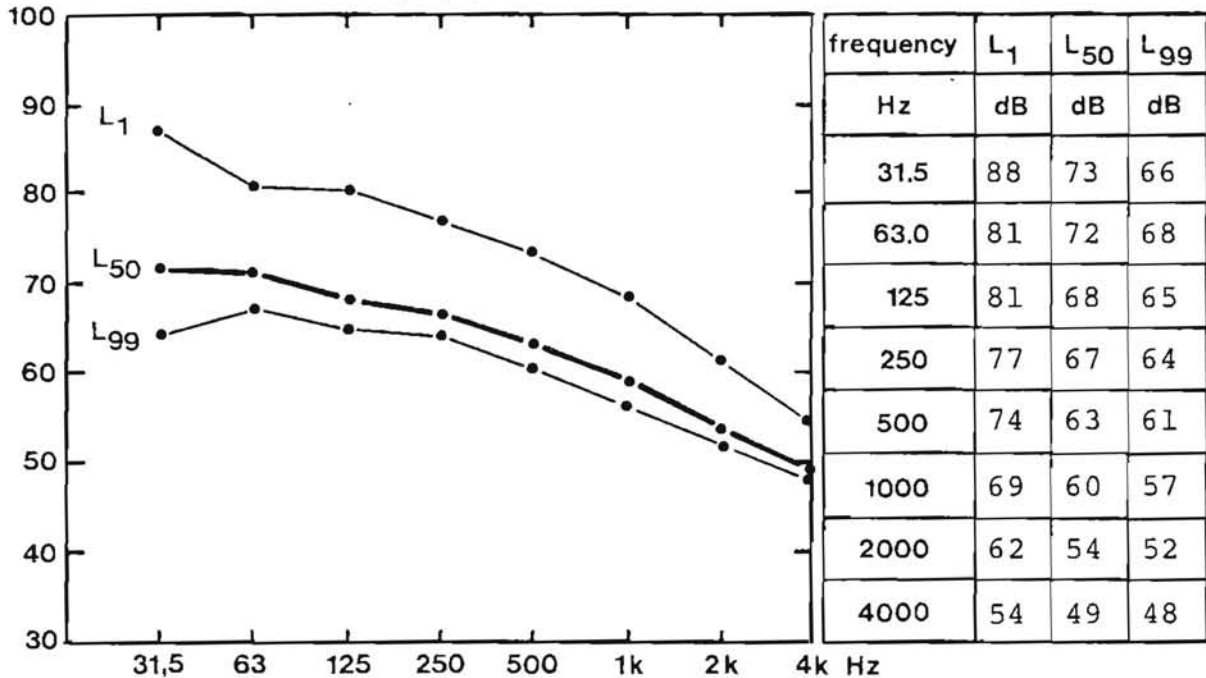
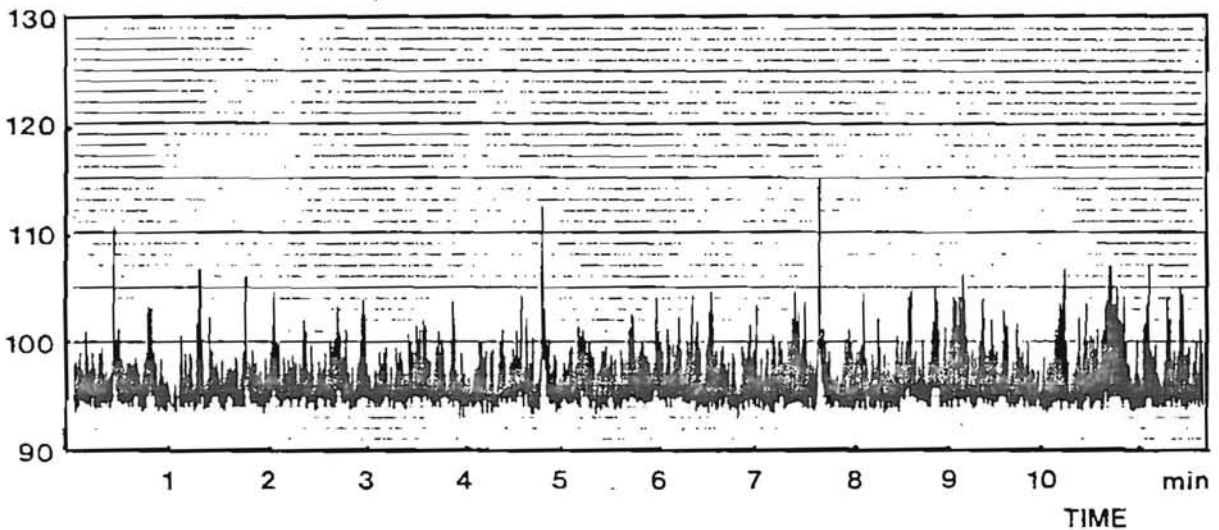
SPECTRUM LEVEL, dB re $1 \mu\text{Pa}/\sqrt{\text{Hz}}$ OVERALL LEVEL, dB re $1 \mu\text{Pa}$ 

Wind: 2-4 m/s
Temperature: 5° C

Wind direction: West
Weather conditions: Overcast

Remarks: As 1 A



A4

Recording No.: 2 A
Date: 25th July 1983
Measuring position: A

Time: 14.45
Water depth: 150 m
Hydrophone depth: 50 m

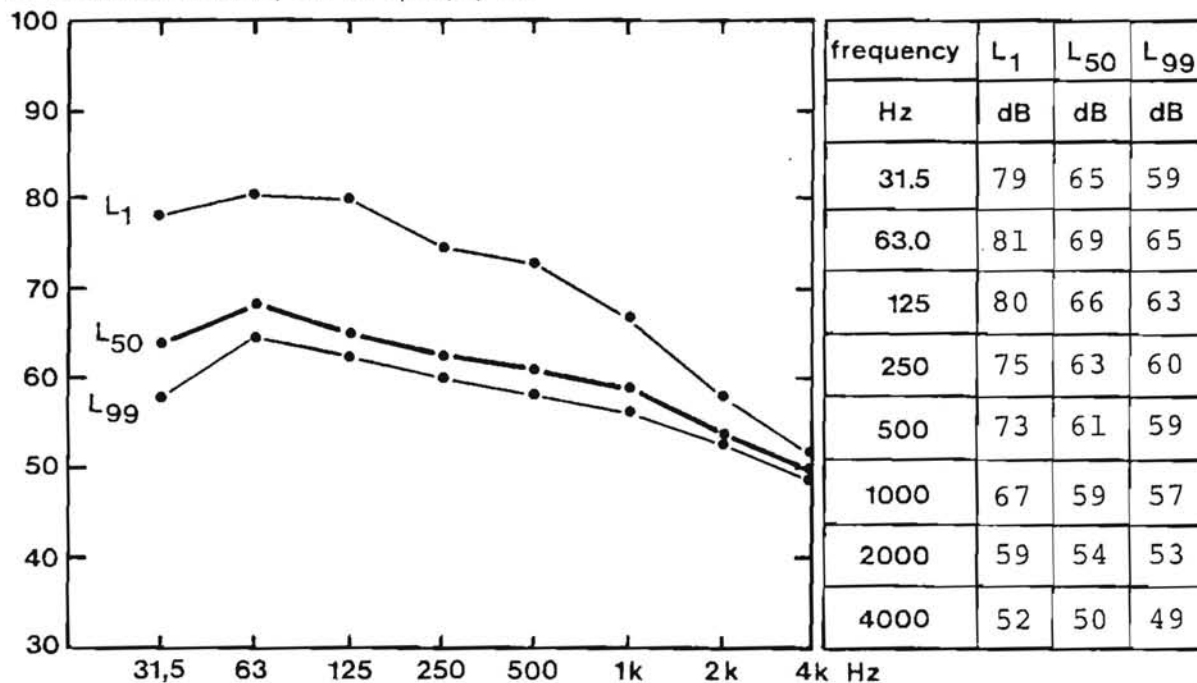
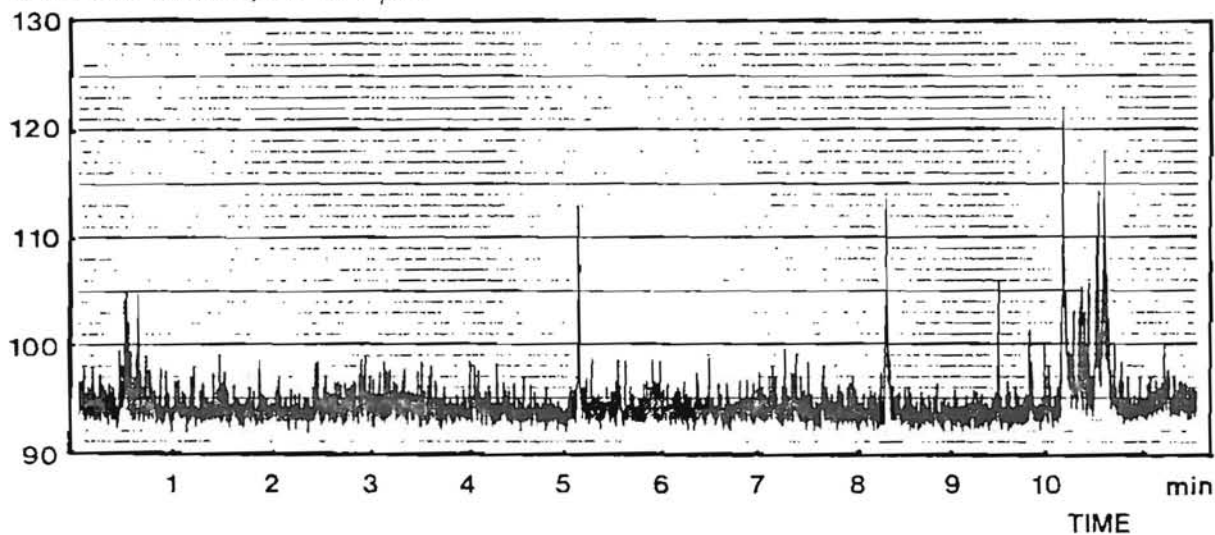
SPECTRUM LEVEL, dB re $1 \mu\text{Pa}/\sqrt{\text{Hz}}$ OVERALL LEVEL, dB re $1 \mu\text{Pa}$ 

Wind: 0-2 m/s
Temperature: 5° C

Wind direction: West
Weather conditions: Overcast

Remarks: As for 1 A



A5

Recording No.: 2 B
Date: 25th July 1983
Measuring position

Time: 14.45
Water depth: 150 m
Hydrophone depth: 5 m

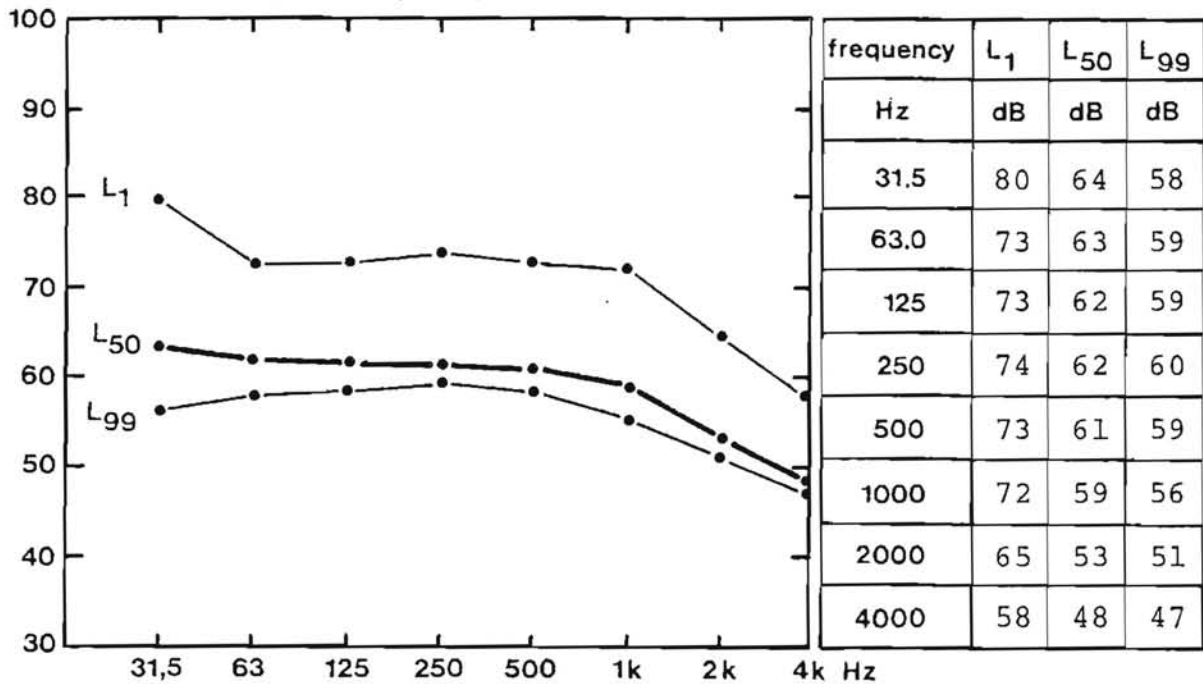
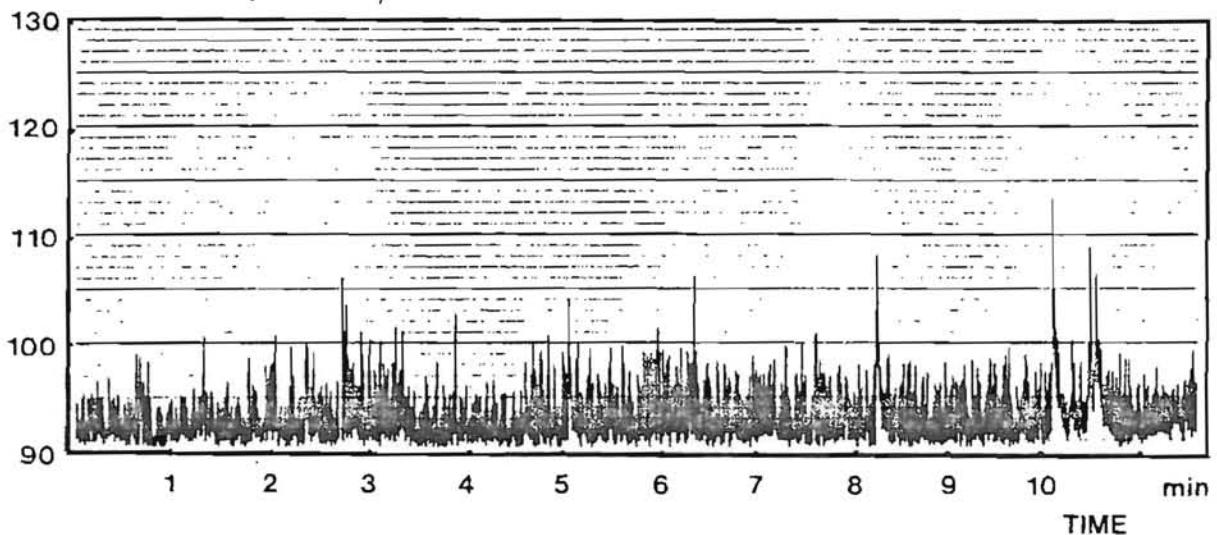
SPECTRUM LEVEL, dB re $1 \mu\text{Pa}/\sqrt{\text{Hz}}$ OVERALL LEVEL, dB re $1 \mu\text{Pa}$ 

Wind: 0-2 m/s
Temperature: 5° C

Wind direction: West
Weather conditions: Overcast

Remarks: As for 1 A



Recording No.: 3 A
Date: 25th July 1983
Measuring position: A

Time: 16.00
Water depth: 150 m
Hydrophone depth: 50 m

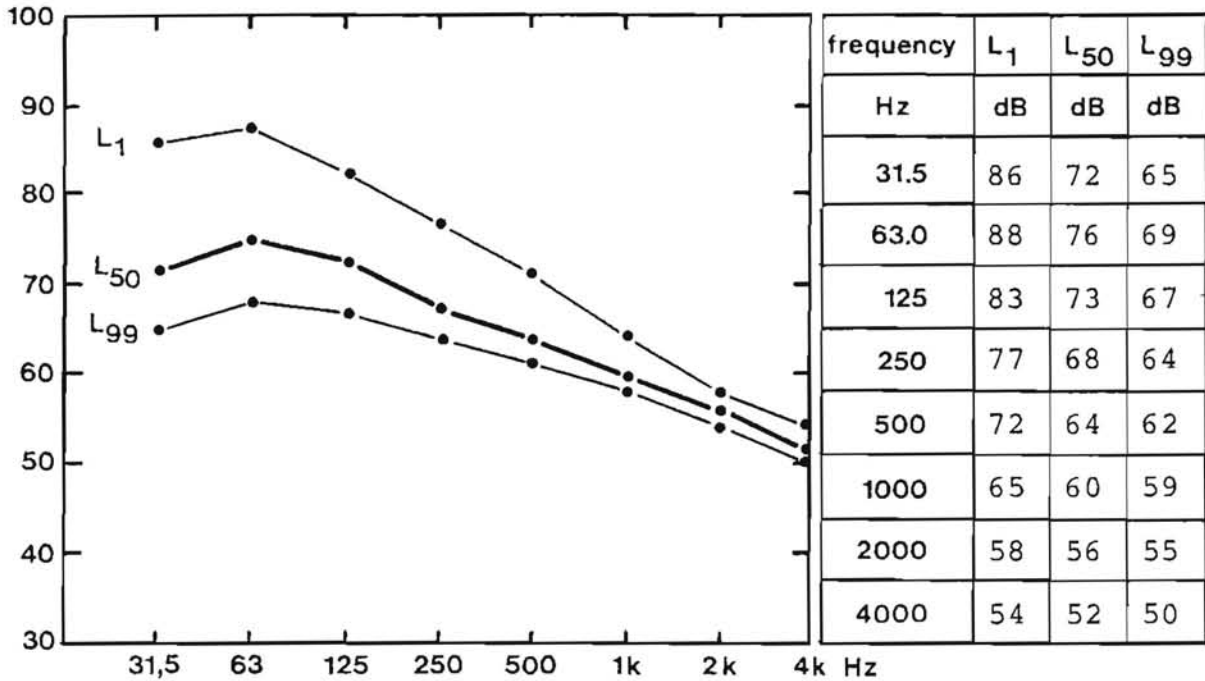
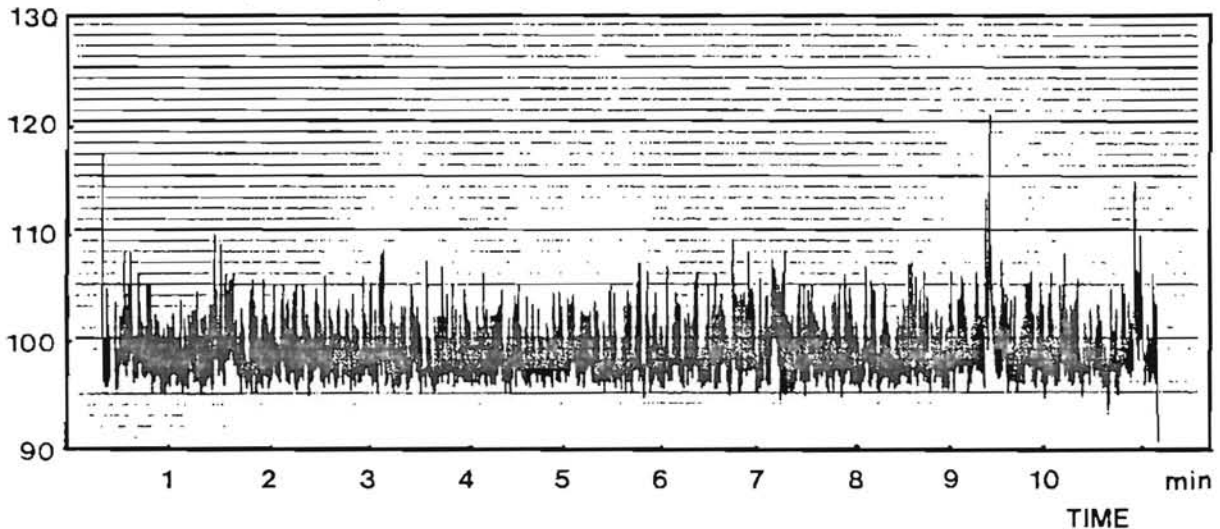
SPECTRUM LEVEL, dB re $1 \mu\text{Pa}/\sqrt{\text{Hz}}$ OVERALL LEVEL, dB re $1 \mu\text{Pa}$ 

Wind: 2-4 m/s Wind direction: West
Temperature: 5° C Weather conditions: Overcast

Remarks: Measured from a bergy bit. Some noise generated by waves interacting with the ice.



A7

Recording No.: 4 A
Date: 25th July 1983
Measuring position: B

Time: 17.30
Water depth: 100 m
Hydrophone depth: 50 m

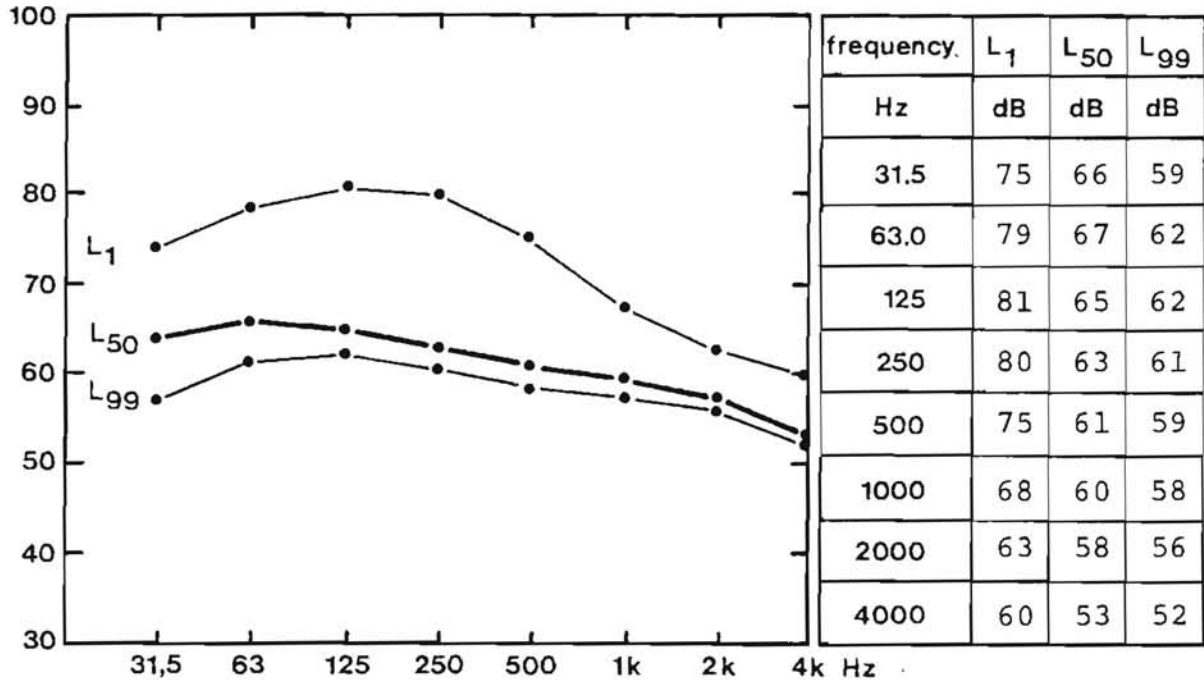
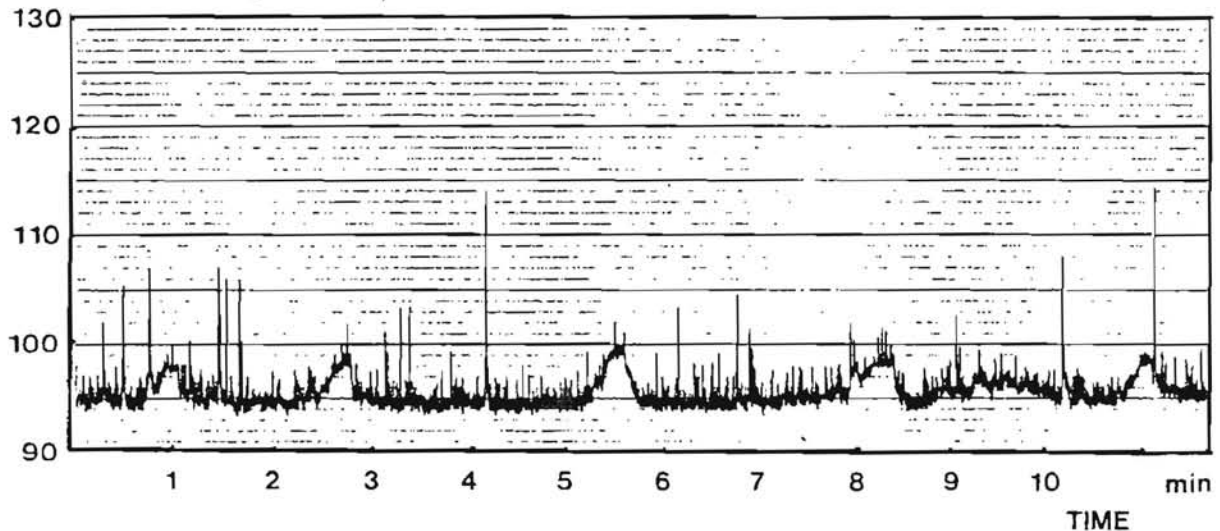
SPECTRUM LEVEL, dB re $1 \mu\text{Pa}/\sqrt{\text{Hz}}$ OVERALL LEVEL, dB re $1 \mu\text{Pa}$ 

Wind: 0 m/s Wind direction: -
Temperature: 5° C Weather conditions: Partial cloud

Remarks: Measured from the dinghy in an area with few icebergs, bergy bits and growlers. Noise from an outboard engine can be heard on parts of the recording, seen as the variations in the base level of the overall noise level. The boat could not be seen from the measuring site.



Recording No.: 4 B
Date: 25th July 1983
Measuring position: B

Time: 17.30
Water depth: 100 m
Hydrophone depth: 5 m

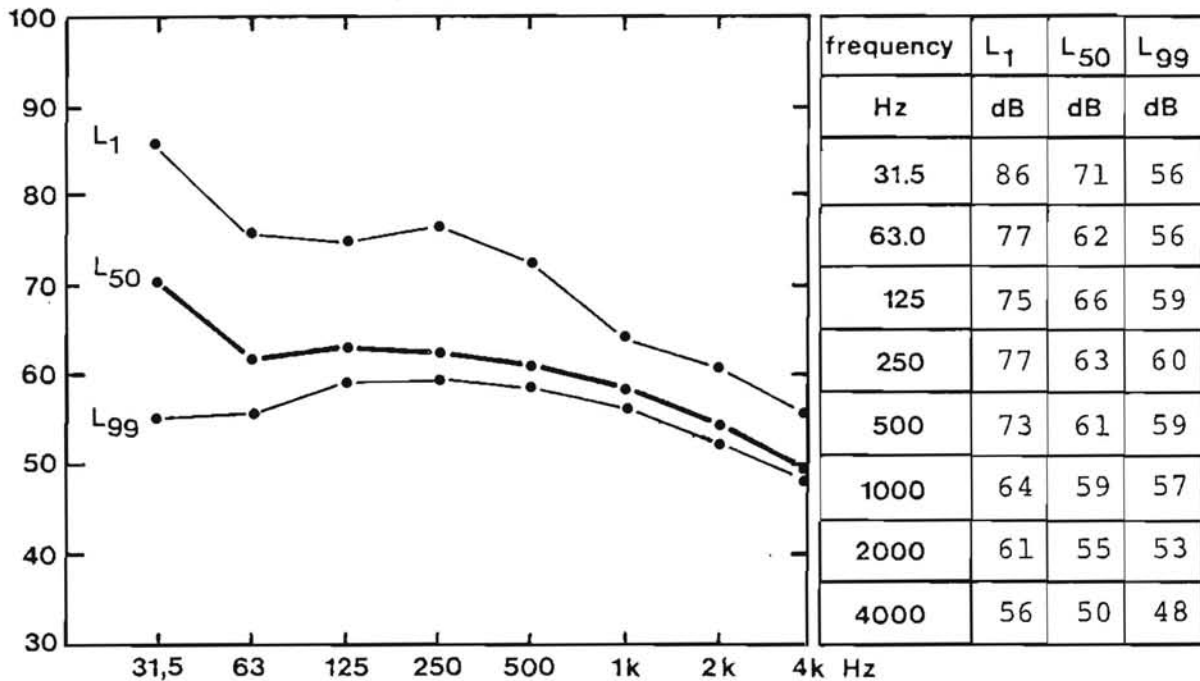
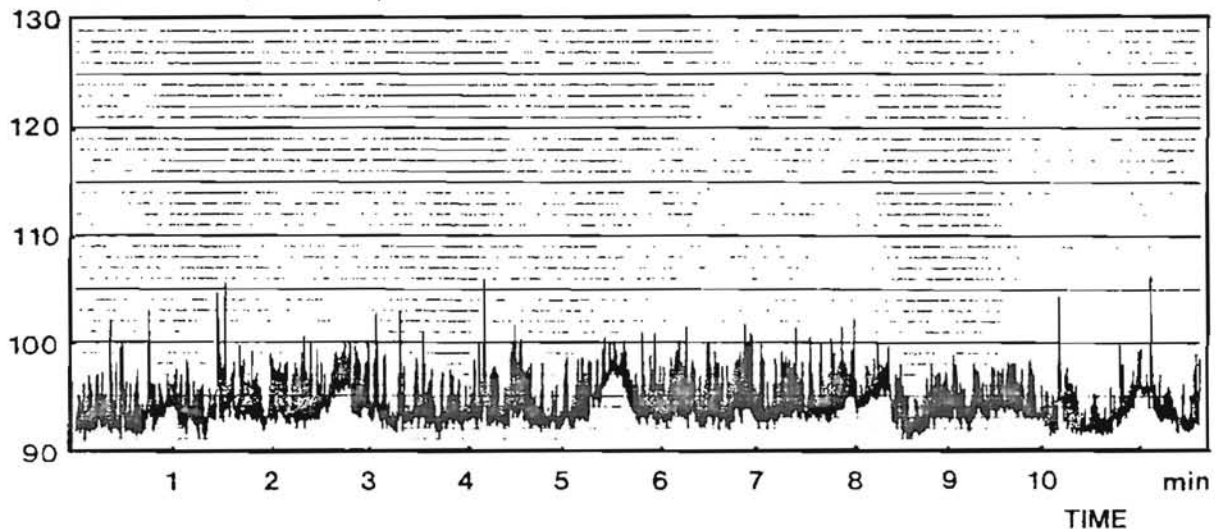
SPECTRUM LEVEL, dB re $1 \mu\text{Pa}/\sqrt{\text{Hz}}$ OVERALL LEVEL, dB re $1 \mu\text{Pa}$ 

Wind: 0 m/s

Wind direction: -

Temperature: 50 C

Weather conditions: Partial cloud

Remarks: As for 4 A



Recording No.: 5 A
Date: 27th July 1983
Measuring position: C

Time: 21.20
Water depth: 900 m
Hydrophone depth: 50 m

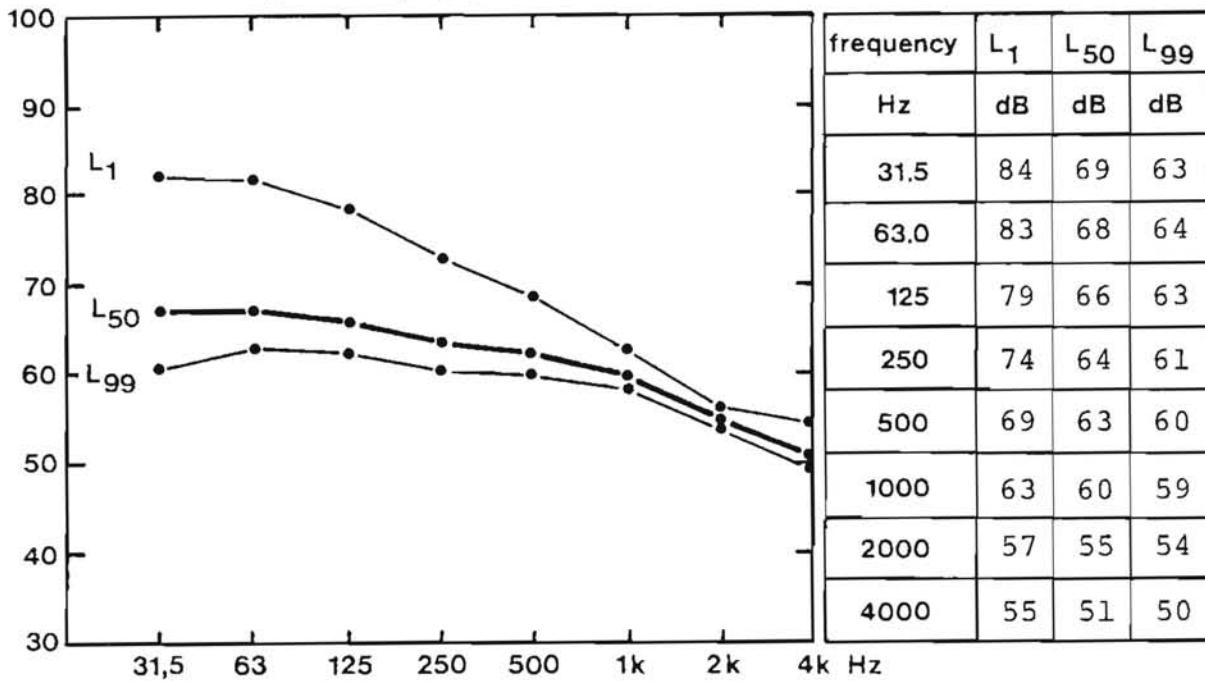
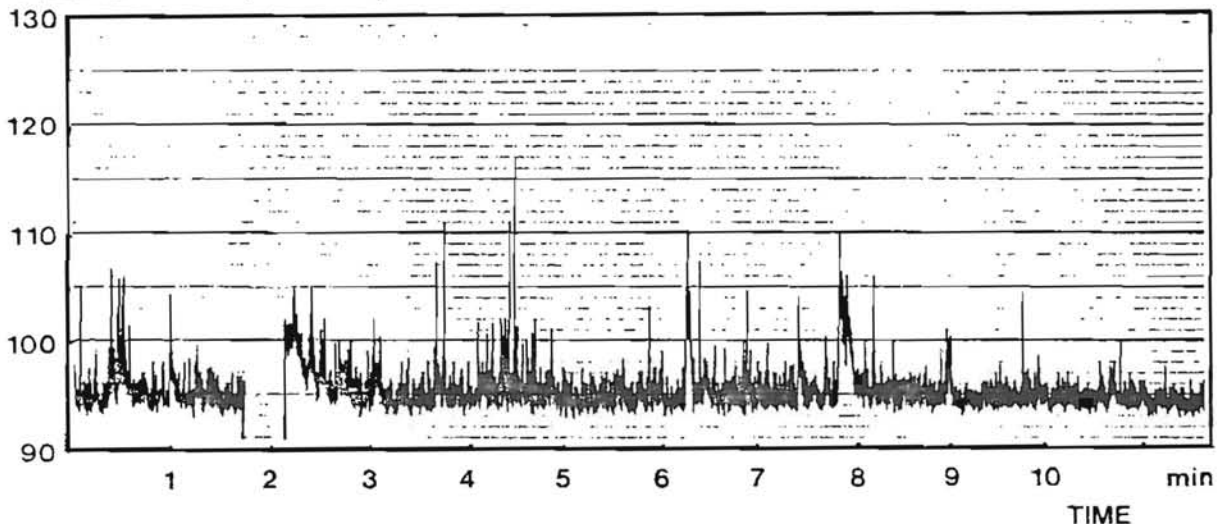
SPECTRUM LEVEL, dB re $1 \mu\text{Pa}/\sqrt{\text{Hz}}$ OVERALL LEVEL, dB re $1 \mu\text{Pa}$ 

Wind: 4 m/s Wind direction: West
Temperature: 5° C Weather conditions: Cloudy

Remarks: Measured from the dinghy tied to a small chunk to prevent drifting. During the recording, the boat was loosend from the ice and started drifting slowly away from it. The recording was stopped, as seen in the overall level recording, when the boat was loosend.



Recording No.: 5 B
 Date: 27th July 1983
 Measuring position: C

Time: 21.20
 Water depth: 900 m
 Hydrophone depth: 5 m

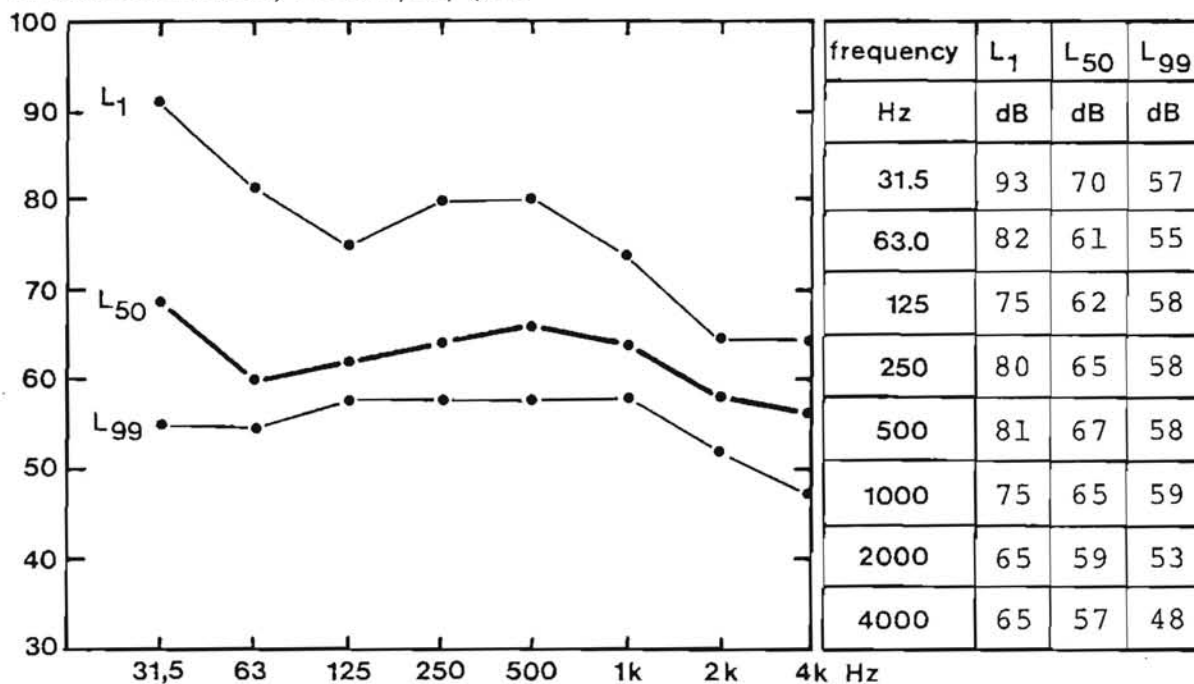
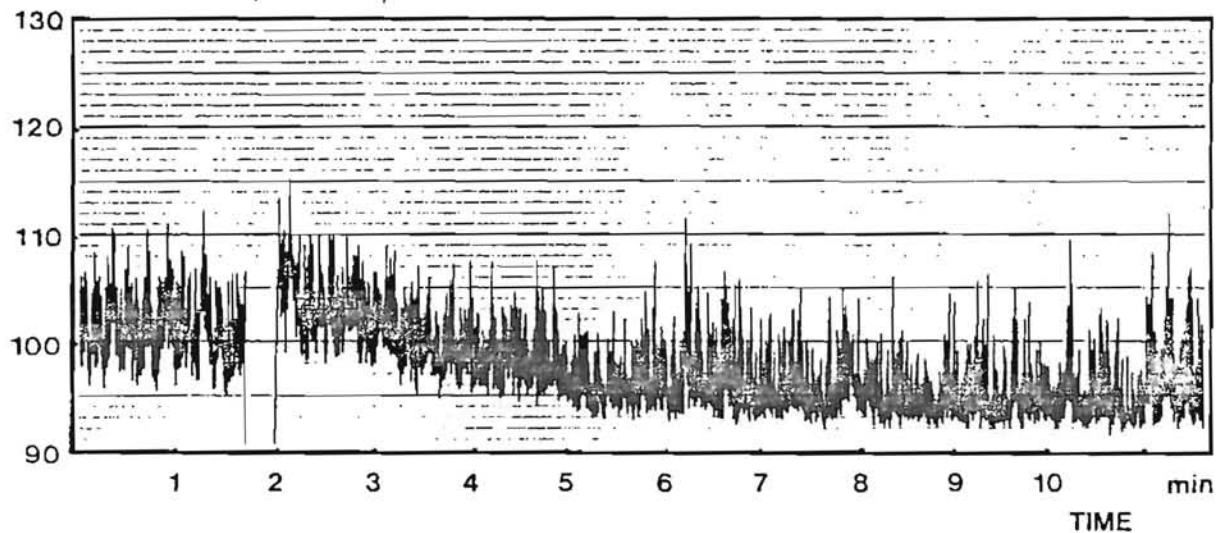
SPECTRUM LEVEL, dB re $1 \mu\text{Pa}/\sqrt{\text{Hz}}$ OVERALL LEVEL, dB re $1 \mu\text{Pa}$ 

Wind: 4 m/s Wind direction: West
 Temperature: 5° C Weather conditions: Cloudy

Remarks: As for 5 A. The overall noise level is seen to decrease by approximately 8 dB when the dinghy drifts away from the growler.



Recording No.: 6 A
Date: 28th July 1983
Measuring position: D

Time: 20.00
Water depth: 750 m
Hydrophone depth: 50 m

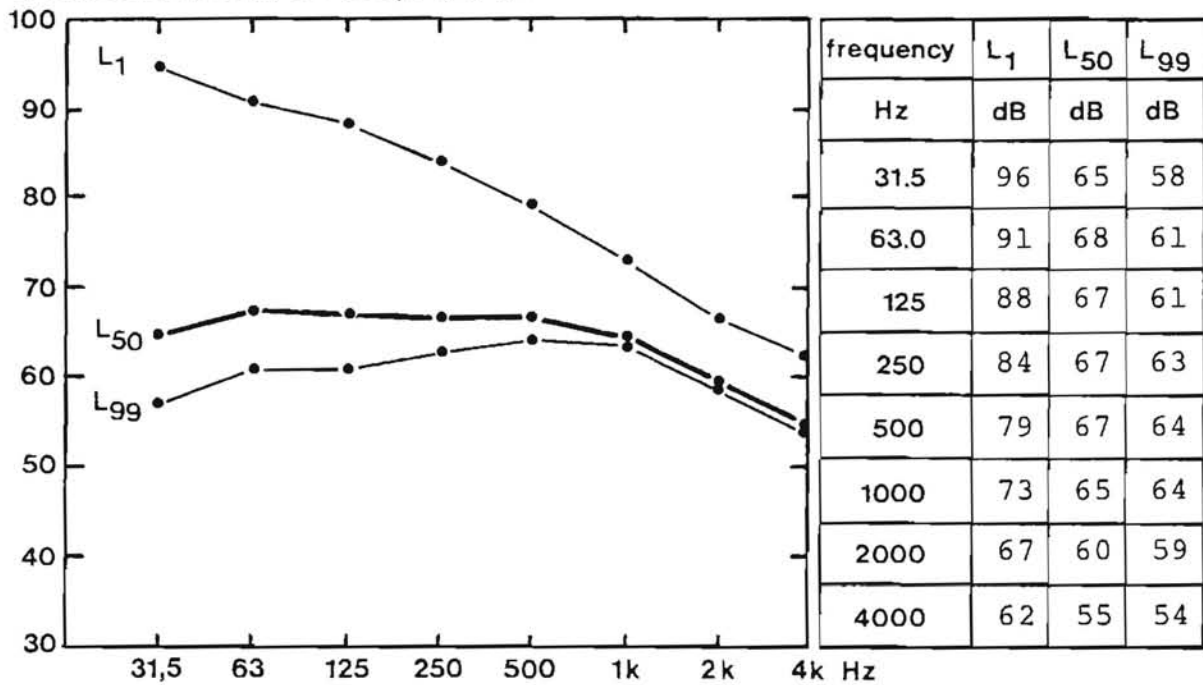
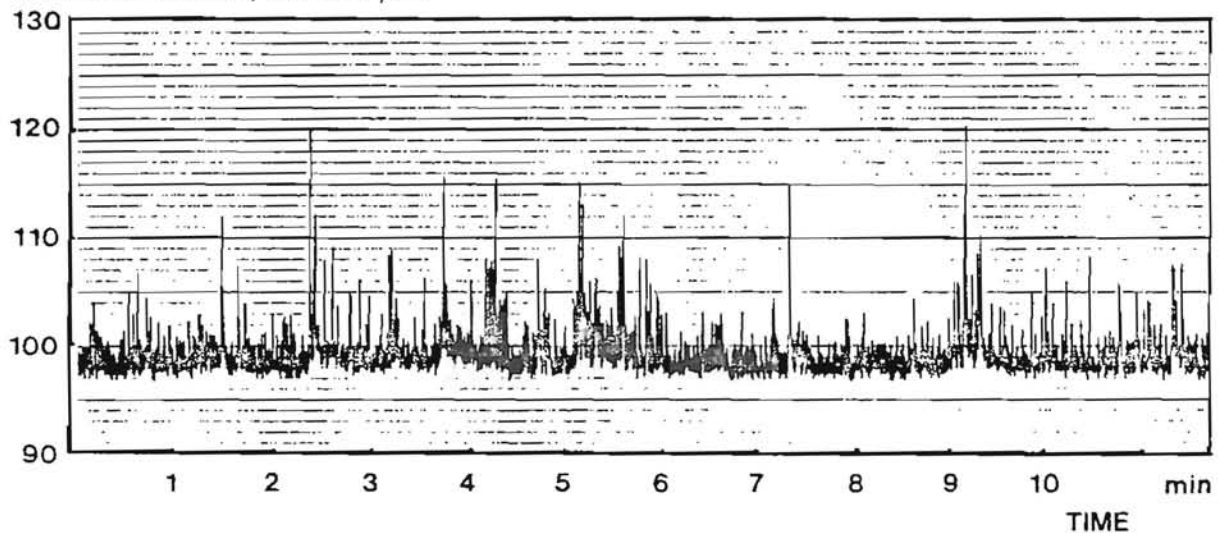
SPECTRUM LEVEL, dB re $1 \mu\text{Pa}/\sqrt{\text{Hz}}$ OVERALL LEVEL, dB re $1 \mu\text{Pa}$ 

Wind: 0 m/s Wind direction: -
Temperature: 8° C Weather conditions: Sunny

Remarks: Measured from the edge of a large ice-covered area. Some icebergs, bergy bits and growlers drifting in the open water.



A12

Recording No.: 6 B
Date: 28th July 1983
Measuring position: D

Time: 20.00
Water depth: 750 m
Hydrophone depth: 5 m

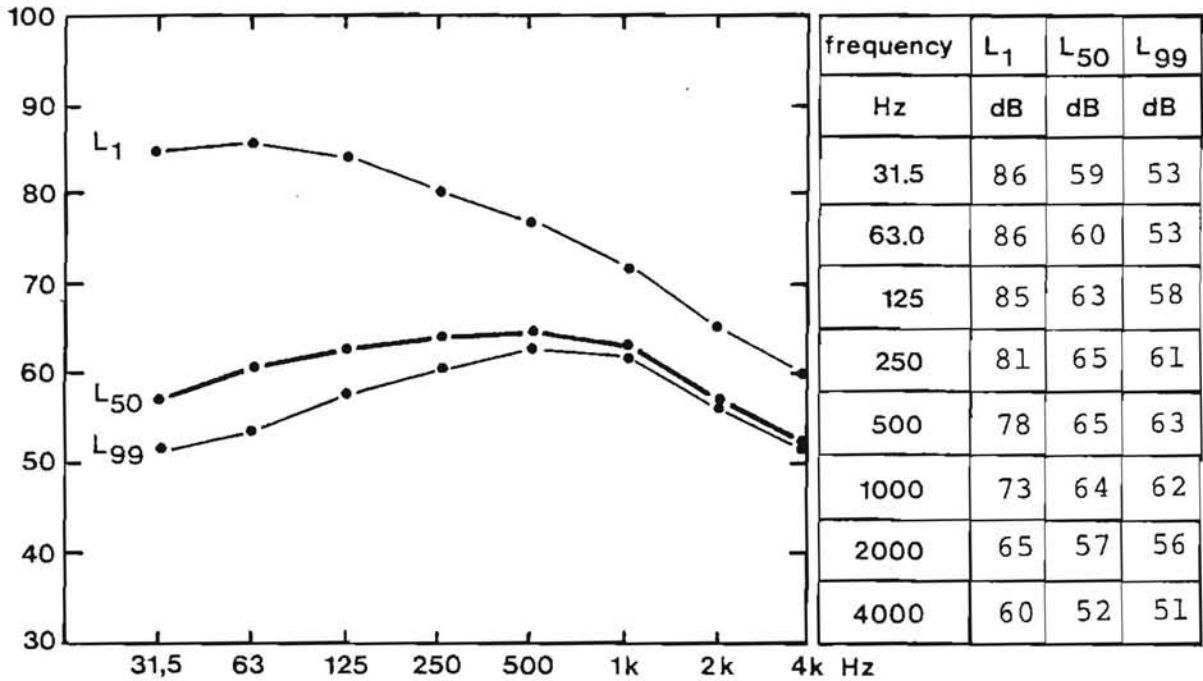
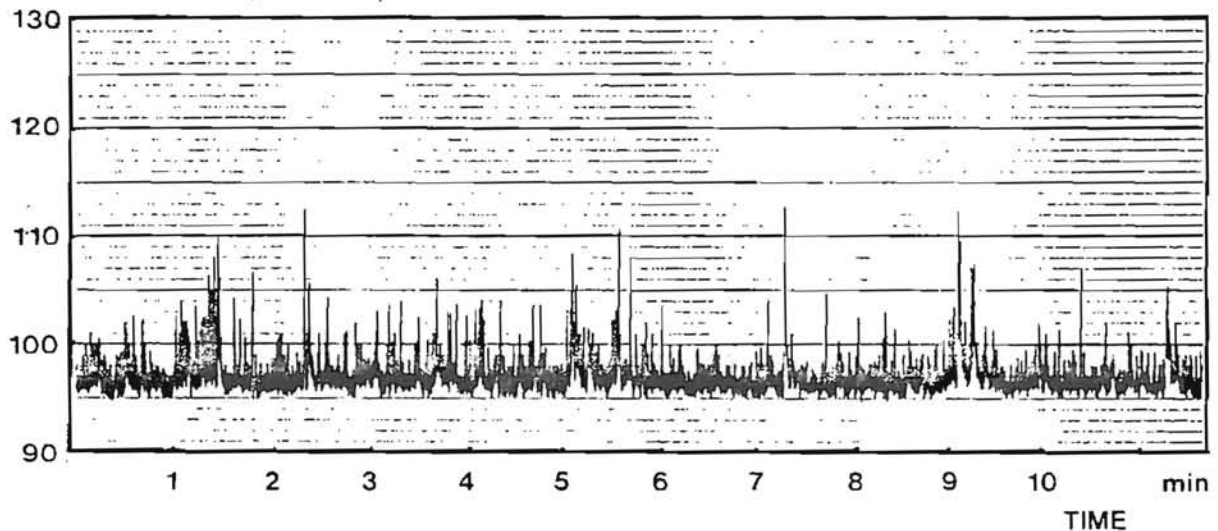
SPECTRUM LEVEL, dB re $1 \mu\text{Pa}/\sqrt{\text{Hz}}$ OVERALL LEVEL, dB re $1 \mu\text{Pa}$ 

Wind: 0 m/s Wind direction -
Temperature: 8° C Weather conditions: Sunny

Remarks: As for 6 A.



Recording No.: 7 B
Date: 29th July 1983
Measuring position: E

Time: 12.00
Water depth: Unknown
Hydrophone depth: 5 m

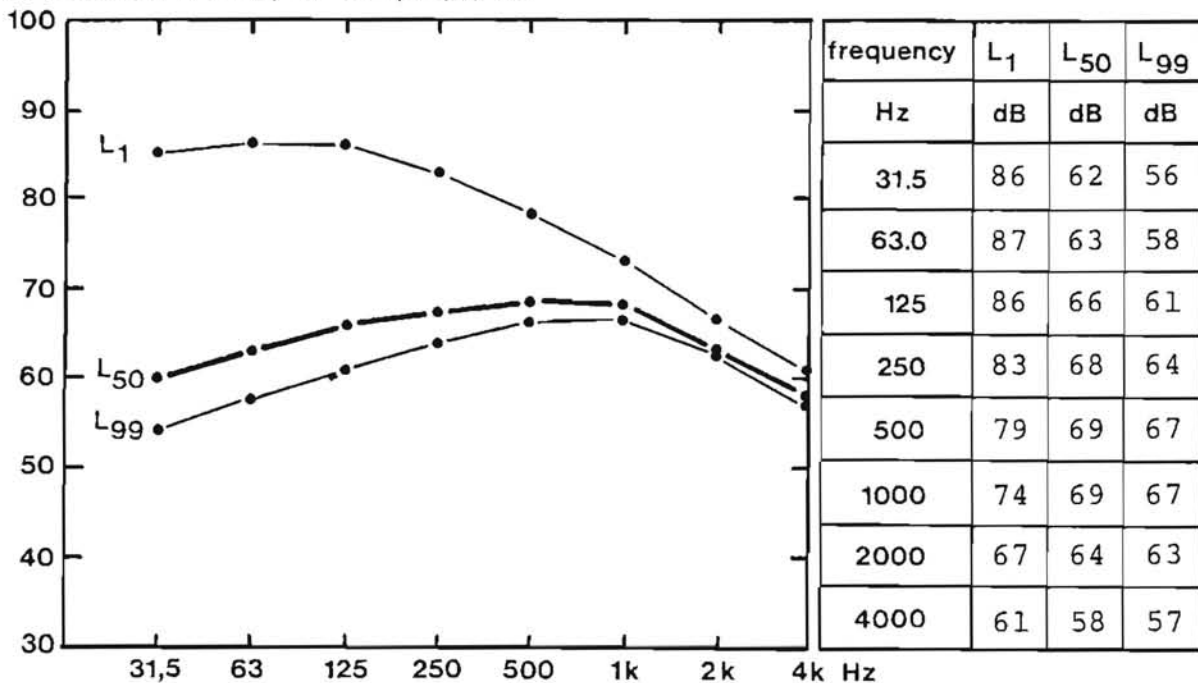
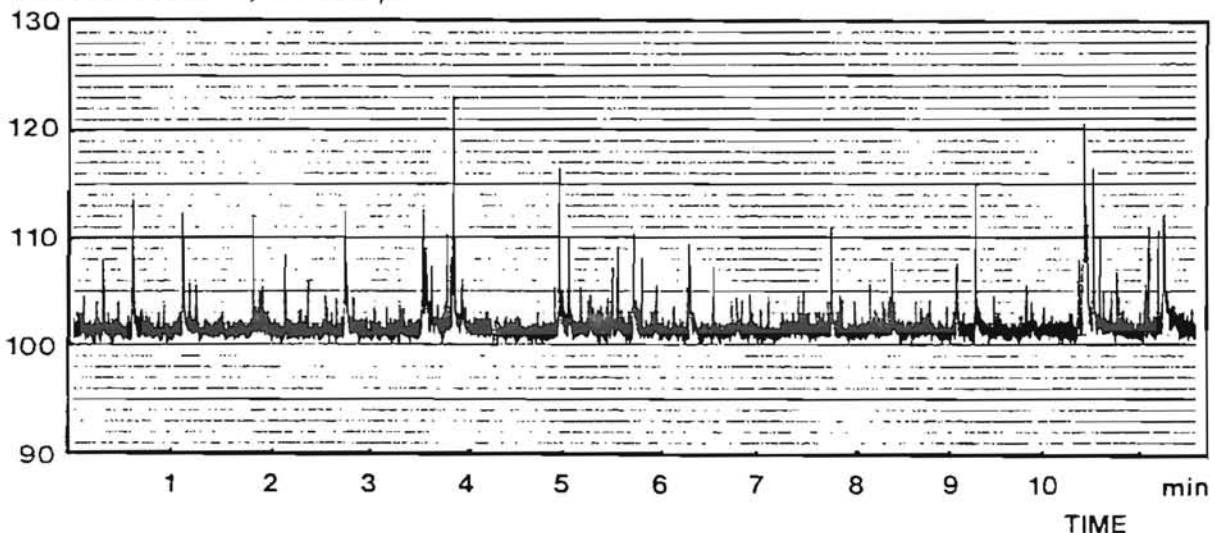
SPECTRUM LEVEL, dB re $1 \mu\text{Pa}/\sqrt{\text{Hz}}$ OVERALL LEVEL, dB re $1 \mu\text{Pa}$ 

Wind: 0 m/s Wind direction: -
Temperature: 8° C Weather conditions: Sunny

Remarks: Measured from a small icefloe drifting in an area with pack ice, (ice concentration 4/10).

Ødegaard & Danneskiold-Samsøe K/S

Rådgivende ingeniører - Støj og vibrationer
Consulting Engineers - Noise and Vibration

Kroghsgade 1
DK-2100 Copenhagen Ø
Denmark
Telefon: 01-26 6011
Telex: 19710 oedan dk

